

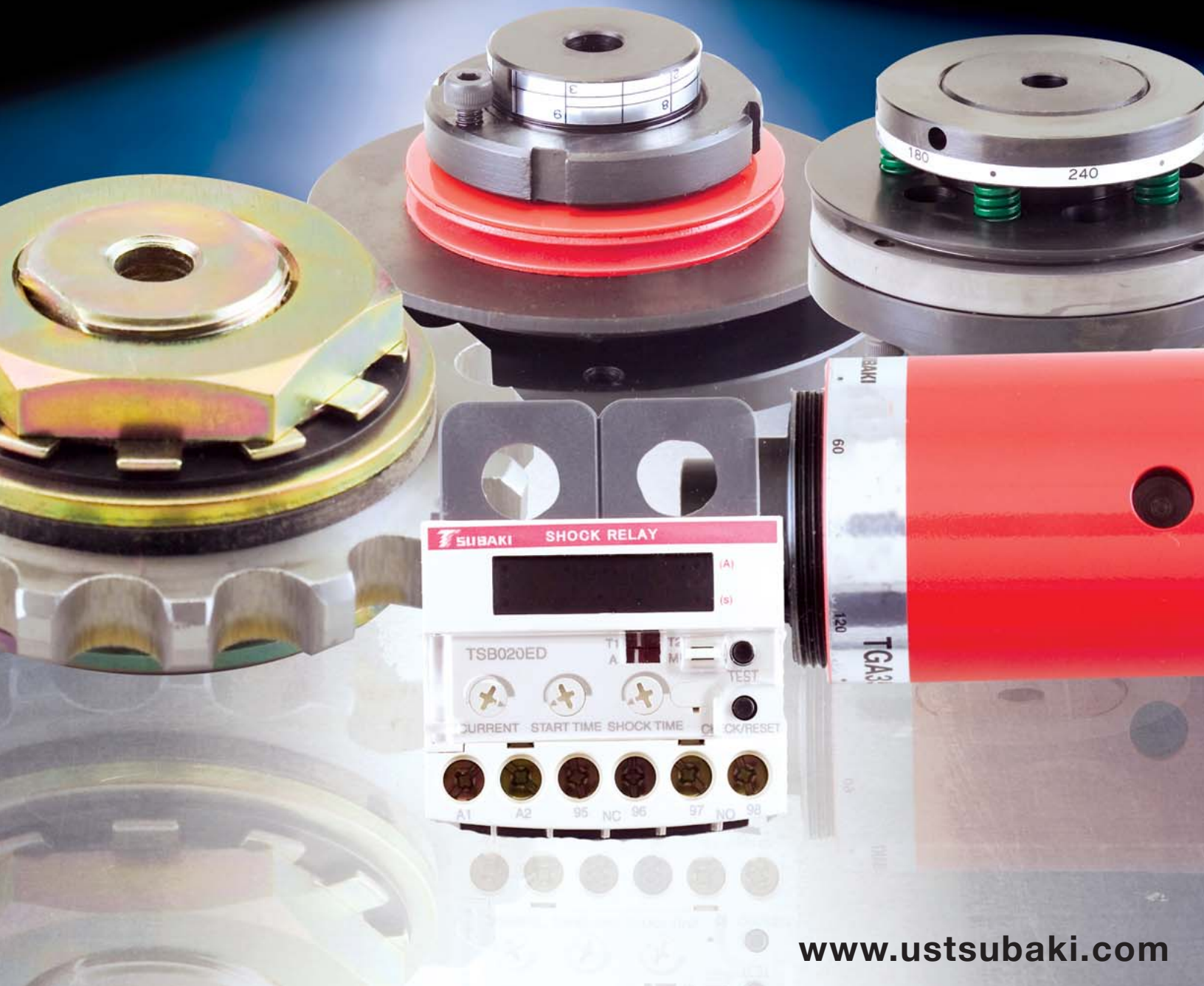

Overload Protection and Safety Devices

Protecting Your Equipment, Protecting Your Investment



The truth is, any machine can break.

Of this we can be sure: Eventually something always happens. And there's no predicting. It's almost a law of nature.

We often learn the hard way: Protection is smart. It saves money. It saves time. In today's environment of cost cutting and just in time delivery, being prepared is just good business sense.

Unintended load changes in the workplace can have big consequences. As equipment becomes more integrated, a shock or jam in one part of the production layout can snowball into a complete system shutdown — damaging equipment and losing product.

It doesn't have to happen.

Tsubaki's SAFCON® family of overload and protection devices offer a solution to fit every need and keep you productive all day, every day, without interruption, so you can get *your* product out the door.

Tsubaki offers not only the finest parts in the industry for your equipment, it also offers protection for those parts and the machinery they belong to. Our SAFCON® family – Shock Relay, Shock Guard, Torque Limiter, and Axial Guard – covers the whole range of needs. One-stop shopping.

You protect what you value. You use seat belts. You have a sump pump in your basement. You wear a helmet when you cycle. Not because things happen everyday, but because they CAN happen.

Are you protecting your equipment?

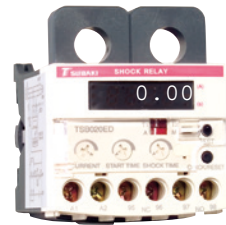

SHOCK RELAY



SHOCK GUARD



TORQUE LIMITER



AXIAL GUARD

Shock Relay



UL Certification

RoHS Compliant

Shock Relay accepts single and three-phase motors up to 600 volts.

Operating Power 24-240 VAC/DC

Shock Relay selection is simple; it is based on the motor amperage of your machinery.

Shock Relay has an unlimited life - it does not wear out.

Pioneered by Tsubaki, the Shock Relay protects your equipment against unexpected shock loads, overloads, and underloads *before* damage occurs. Shock Relay protects the mechanical parts of your equipment by monitoring the current on your motor and shutting it down when the motor works too hard for too long.

Advantages to you:

- Back to work with the press of a button
- No parts to replace
- Precision adjustment and setting
- Little potential for nuisance trips
- Monitors and protects equipment from up to 1,000 feet away

The Shock Relay adapts to virtually any kind of equipment that's driven by an electric motor and is used in applications in a broad variety of industries, including:

INDUSTRY	APPLICATION
Material handling	Conveyors, turntables, elevators
Water treatment plants	Pumps, scrapers, water screens
Food machinery	Screw and belt conveyors, bucket elevators
Machine tool	Tapping machines, drill presses
Chemical	Pumps, agitators, filters

We've thought of everything.

The Shock Relay knows when the motor driving your operation is working too hard. It's simple: you set the load current so Shock Relay knows where your motor should be operating. And it knows, too, when a surge is dangerous because you determine the time of an acceptable momentary surge, allowing Shock Relay to ignore small variations. Your adjustment of the start time setting prevents the Shock Relay from engaging during start up when the current draw of a motor is greater than the running current.

Unlike mechanical devices like the Shear Pin Sprocket, which requires downtime to fix, U.S. Tsubaki's Shock Relay resets at the press of a button. That's it.



SHOCK RELAY

Adding the Tsubaki Shock Relay to your existing Start/Stop circuit is easy. Generally, no advanced knowledge of electronics is necessary. Just a few wires and a few adjustments quickly can result in less down time and lower maintenance costs.

The Shock Relay protects your mechanical components. Thermal relays and Inverters do not, their purpose is different, their protection is different. Using the correct tool saves time and money.

In the past, heavy loads and hard-working equipment required large shear pins and bulky safety devices. Tsubaki has changed the equation. Bigger motors do not equal a more expensive Shock Relay. Simple, reliable, user-friendly.



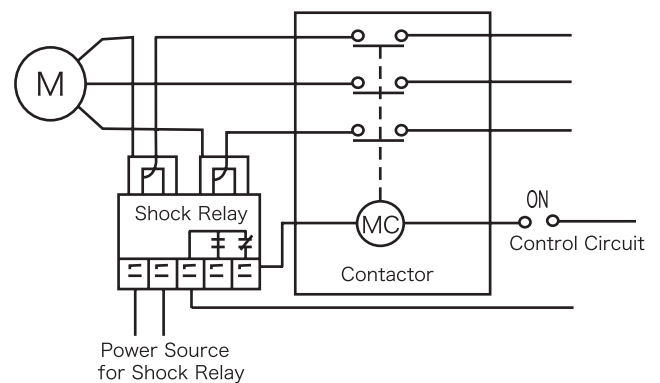

Sample Wiring Configuration

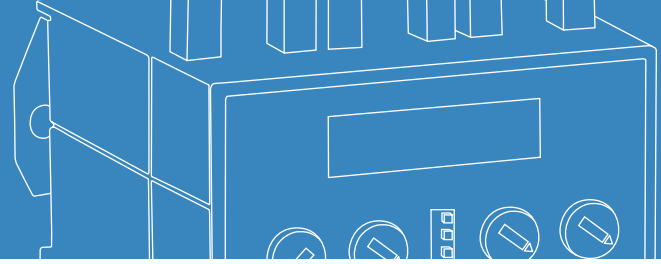

No advanced knowledge of electronics is necessary.

Motor size does not determine cost. Bigger motors don't require a more expensive Shock Relay.



	<p>TSBED SERIES 2.77H x 2.20W x 3.04D</p>	<p>Designed to work with inverters. Digital display. Built-in tamper-proof cover and built-in test button. Choose between self-holding output relay and automatic reset.</p>
	<p>TSB150 SERIES 4.5H x 4.9W x 4.33D</p>	<p>The original Shock Relay with self-holding circuit and analog meter. Four series available: Standard Overload, Pre-Alarm notification, Impact detection, Over and Underload protection.</p>
	<p>TSBSB SERIES 2.44H x 2.13W x 2.60D</p>	<p>The most popular model for overload protection. Has a built-in reset button, test button or automatic reset. Unit has UL/cUL Certification, CE marking and is RoHS compliant.</p>
	<p>TSBSM SERIES 2.96H x 2.16W x 3.03D</p>	<p>Compact, all-in-one, and economically priced. Limited features but perfect for the OEM customer. Special MTO amperages available.</p>
	<p>TSB50 2.75H x 2.36W x 3.07D</p>	<p>Automatic reset with fixed start-time to accommodate motor in-rush current. Dual output contacts allow many wiring options. Two-piece construction aids fitting into crowded panels.</p>

MODEL	SIZE	AMPERAGE RANGE	START TIME RANGE	SHOCK TIME RANGE	OUTPUT CONTACT RATING	MOUNTING
TSBED	020 075 220 550	0.2 ~ 2.4A 1.2 ~ 5.8A 3.0 ~ 14A 6.0 ~ 34A	0.2 ~ 10s	0.2 ~ 5.0s	3A, 250VAC	35mm DIN or surface mount
TSB150 Std, A, M, and W styles	151 152-100 152-200 152-300 152-400	0.3 ~ 16A 10 ~ 100A 60 ~ 200A 90 ~ 300A 120 ~ 400A	0.2 ~ 20s	0.2 ~ 3s	0.2A, 250VAC	Two components, both surface mount
TSBSB	05 10 30 60	0.5 ~ 6A 1 ~ 12A 3 ~ 30A 5 ~ 60A	0.2 ~ 10s	0.2 ~ 5s	3A, 250VAC	35mm DIN or surface mount
	100 200 300	10 ~ 100A 20 ~ 200A 30 ~ 300A	0.2 ~ 10s	0.2 ~ 5s	3A, 250VAC	TSBSB05 plus surface mount transformer
TSBSM	02	0.5 ~ 2A	1.5s fixed	1.0s fixed	3A, 250VAC	Surface mount
TSB50		0.4 ~ 16A	3s fixed	0.3 ~ 3s	0.1A, 250VAC	Two components, both surface mount

Setup is typically easiest when the max amperage of the Shock Relay is close to the motor amperage.

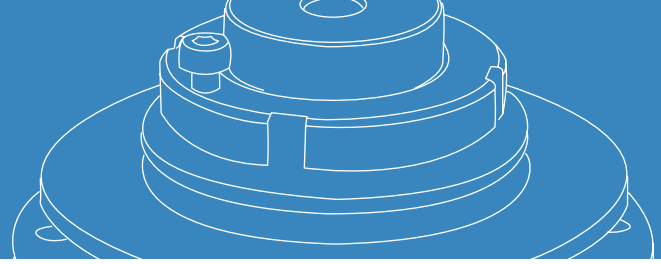

Shock Guard

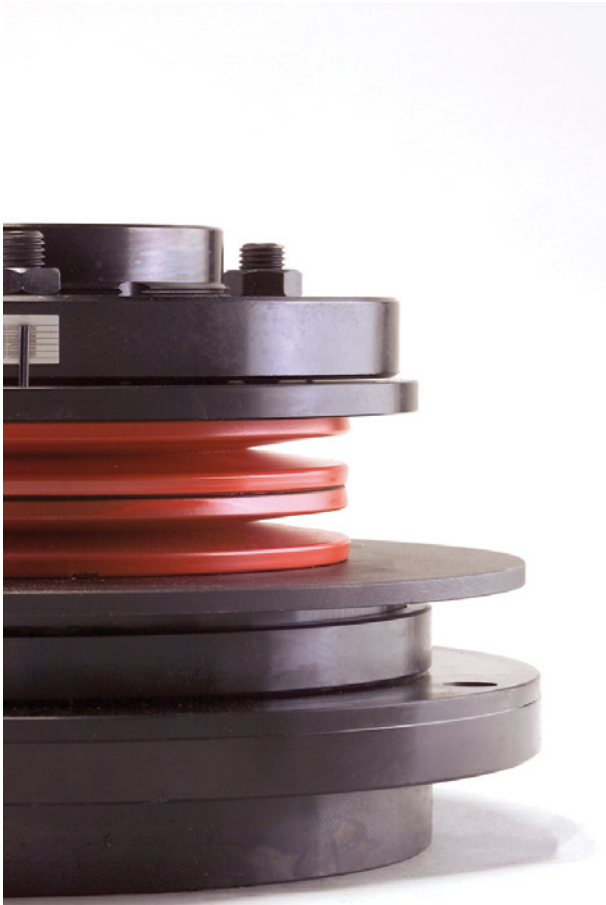

Manual disengagement feature assists with machine maintenance.

High speed or low speed service, bi-directional rotation.

Disengages at a pre-set torque rating. Protects your equipment against the unexpected.

Quick and easy reset.

Tsubaki's Shock Guard is a ball and detent mechanical device that offers enhanced precision over other mechanical devices. Bearing the brunt of the load when tripped, the Shock Guard reacts instantly to save equipment and product. The Shock Guard's one-position design allows each ball to return to its unique location when it resets so that your equipment resumes its work exactly where it was before the jam or overload.

Advantages over other devices:

- Instant and complete disengagement
- Accurate and consistent torque setting
- Automatic re-engagement limits downtime and need for maintenance worker to switch tasks
- Externally adjustable trip torque speed installation and setup
- Backlash free operation

INDUSTRY	APPLICATION
Transport	Conveyors, turntables, elevators
Pumping	Pumps, agitators, filters
Plastic processing	Screw and belt conveyors, bucket elevators
Metal working	Tapping machines, drill presses
Environmental	Water gate, water screen
Packaging	Bag making, cartoning, vacuum packing
Food processing	Noodle making, flour mill

The Shock Guard is ideal in a wide range of settings and is especially suited for more sophisticated applications that may be prone to jams. Users require a consistent and predictable trip point with quick resetting so that production is maintained and each line stays in sync with where it left off.

Shock Guard is easy to set and adjust with its built-in meter and indicator having distinct torque setting points for easy verification. The asymmetrical arrangement of balls and pockets allows for same-position resetting. Once the jam or overload is removed, Shock Guard reengages automatically by joggling the outer drive hub. Tsubaki offers a series of four categories of Shock Guard to support all your protection needs.

Shock Guard Series

TGB SERIES

An economical choice for general use. The TGB series can be used with almost any machine. Offers automatic resetting, easy-to-read torque indicator, and no backlash.



TGM SERIES

The gasket and O-ring sealed construction in the TGM series is unique. Excels in wet, dusty, and oily applications. Designed for long life, tough environments.



TGX SERIES

A high-precision option, the TGX series features no backlash and unsurpassed operation rigidity. Ideal for machines that require accurate positioning.



TGZ SERIES

A release-type protection device, the TGZ series offers on-off clutch capability. Its simple and straightforward adjustments make it easy to use.



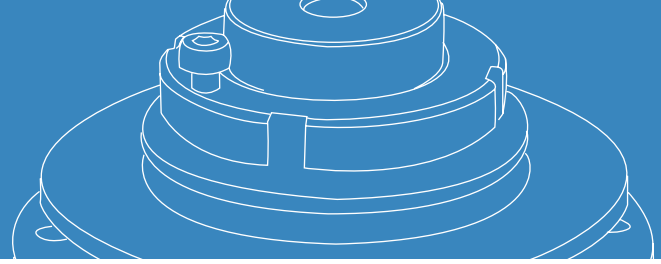

TGB SERIES

An economical choice for general use.

The TGB series can be used with almost any machine. Offers automatic resetting, easy-to-read torque indicator, and no backlash.



SPECIFICATIONS

Select based on torque required, rpm, and shaft diameter:

MODEL	TORQUE RANGE (FT. - LBS.)	MAXIMUM RPM	ROUGH STOCK BORE	MAXIMUM BORE DIAMETER	A	E	F (P.C.D.)	G	WT (LBS.)
TGB08-L	0.2 ~ 1.1	1200	0.20	0.31	1.54	1.575	1.339	1.02	0.3
TGB08-M	0.6 ~ 1.6								
TGB08-H	0.9 ~ 2.2								
TGB12-L	0.5 ~ 2.2	1000	0.24	0.47	1.85	1.890	1.575	1.26	0.5
TGB12-M	1.4 ~ 3.6								
TGB12-H	2.2 ~ 4.3								
TGB16-L	1.1 ~ 3.6	900	0.28	0.63	2.20	2.283	1.969	1.54	1.0
TGB16-M	2.2 ~ 5.8								
TGB16-H	4.3 ~ 8.7								
TGB20-H	7.0 ~ 33	700	0.31	0.79	1.85	3.543	3.071	2.44	2.0
TGB30-L	14 ~ 40								
TGB30-H	39 ~ 123								
TGB50-L	50 ~ 109	500	0.47	1.18	2.36	4.449	3.937	3.23	4.4
TGB50-M	100 ~ 304								
TGB50-H	144 ~ 398								
TGB70-H	216 ~ 796	300	0.87	1.97	3.19	6.299	5.591	4.80	13.0
TGB90-L	325 ~ 976								
TGB90-H	686 ~ 2,313								
TGB110-L	506 ~ 1,446	160	1.26	2.76	4.33	8.661	7.874	6.69	37.5
TGB110-H	1,156 ~ 3,760								
TGB130-L	868 ~ 2,240								
TGB130-H	1,950 ~ 5,200	120	1.65	3.54	6.18	11.61	10.433	9.29	82.7
TGB110-L	506 ~ 1,446								
TGB110-H	1,156 ~ 3,760								
TGB130-L	868 ~ 2,240	100	2.05	4.33	7.68	13.98	12.795	11.30	153
TGB130-L	868 ~ 2,240								
TGB130-H	1,950 ~ 5,200								
TGB130-L	868 ~ 2,240	80	2.36	5.12	9.06	15.75	14.173	12.56	225
TGB130-L	868 ~ 2,240								
TGB130-H	1,950 ~ 5,200								

TGB08~TGB16

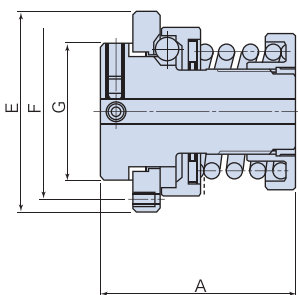

TGB20~TGB50

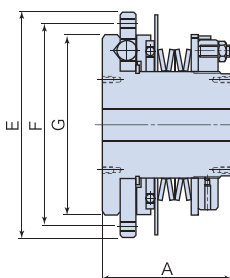

TGB70~TGB130

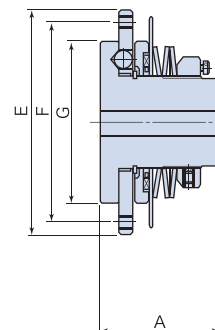

TGM SERIES

The gasket and O-ring sealed construction in the TGM series is unique. Excels in wet, dusty, and oily applications. Designed for long life, tough environments.



TORQUE SHIELD

SELECTION

Select based on torque required, rpm, and shaft diameter:

MODEL	TORQUE RANGE (LBS. - FT.)	MAXIMUM RPM	BORE RANGE	A	F	G	H	I	WT (LBS.)
TGM3	1.1 ~ 2.7	600	0.39 ~ 0.55	2.36	3.15	0.87	1.181	1.97	1.3
TGM6	1.8 ~ 4.7	600	0.39 ~ 0.55	2.36	3.15	0.87	1.181	1.97	1.3
TGM20	4.7 ~ 14.5	500	0.55 ~ 0.79	2.76	3.94	1.18	1.575	2.36	2.4
TGM60	14.5 ~ 50	300	0.79 ~ 1.18	3.50	5.24	1.87	2.362	3.39	5.5
TGM200	50 ~ 166	200	1.10 ~ 1.97	4.33	7.00	2.75	3.228	5.24	11.9
TGM400	166 ~ 333	150	1.50 ~ 2.36	6.18	10.75	3.50	4.488	7.48	37.8
TGM800	333 ~ 665	150	1.50 ~ 2.36	6.18	10.75	3.50	4.488	7.48	37.8

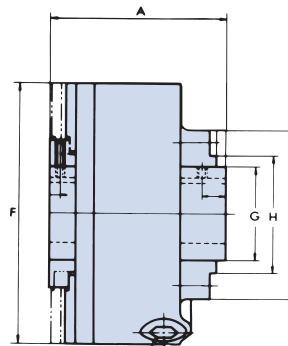

Adjustment screw (hexagon head cap screw)

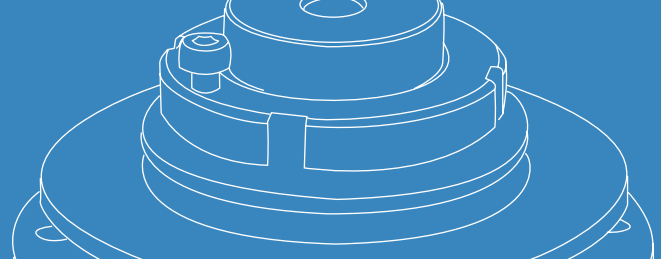

TGX SERIES

A high-precision option, the TGX series features no backlash and unsurpassed operation rigidity. Ideal for machines that require accurate positioning.

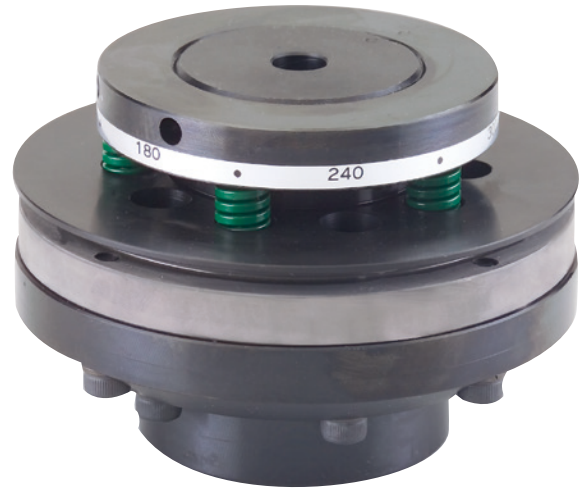

SELECTION

Select based on torque required, rpm, and shaft diameter:

MODEL	TORQUE RANGE (FT. - LBS.)	MAXIMUM RPM	ROUGH STOCK BORE	MAXIMUM BORE DIAMETER	A	G	H (PCD)	J (PCD)	Q (SCREW DIA. AND LENGTH)	U (SCREW DIA. AND LENGTH)	WT (LBS.)
TGX10-L	1.2 ~ 4.7	1400	0.27	0.59	2.09	2.441	2.126	1.339	M4 x 6	M4 X 7	1.7
TGX10-M	4.0 ~ 10.9										
TGX10-H	8.0 ~ 21.7										
TGX20-L	4.8 ~ 17.4	1100	0.33	0.98	2.52	3.386	2.913	1.969	M5 x 8	M4 X 7	3.7
TGX20-M	9.6 ~ 25.1										
TGX20-H	18.8 ~ 50										
TGX35-L	17 ~ 50	800	0.47	1.38	2.68	4.213	3.465	2.362	M6 x 7	M5 X 8	5.5
TGX35-M	32 ~ 72										
TGX35-H	64 ~ 145										
TGX50-L	33 ~ 87	600	0.71	2.17	3.62	5.827	5.118	-	M8 x 13	-	15
TGX50-M	66 ~ 145										
TGX50-H	130 ~ 289										
TGX70-L	94 ~ 268	480	0.91	2.76	3.86	7.283	6.457	-	M10 x 13	-	25
TGX70-M	195 ~ 376										
TGX70-H	289 ~ 578										

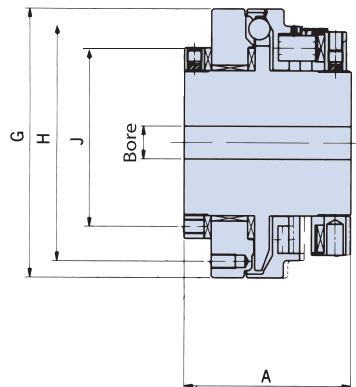

TGZ SERIES

A release-type protection device, the TGZ series offers on-off clutch capability. Its simple and straightforward adjustments make it easy to use.



TORQUE SHIELD

SELECTION

Select based on torque required, rpm, and shaft diameter:

MODEL	TORQUE RANGE (FT. - LBS.)	MAXIMUM RPM	ROUGH STOCK BORE	MAXIMUM BORE DIAMETER	A	H	J	K (PCD)	L	U (SCREW DIA. AND LENGTH)	WT (LBS.)
TGZ20-L	1.7 ~ 6.1	1800	0.32	0.79	2.91	0.43	3.78	3.386	2.835	M5 X 10	5.7
TGZ20-M	3.0 ~ 11.6										
TGZ20-H	6.0 ~ 23.1										
TGZ30-L	4.3 ~ 15.2	1800	0.47	1.18	3.29	0.45	4.65	4.173	3.425	M6 X 12	9.2
TGZ30-M	14.5 ~ 38.3										
TGZ30-H	28.9 ~ 79.5										
TGZ40-L	18 ~ 69	1800	0.67	1.57	3.98	0.55	5.98	5.472	4.488	M6 X 12	19
TGZ40-M	32 ~ 94										
TGZ40-H	65 ~ 181										
TGZ50-L	46 ~ 116	1800	0.87	1.97	4.51	0.63	7.01	6.378	5.236	M80 X 16	30
TGZ50-M	94 ~ 224										
TGZ50-H	181 ~ 333										

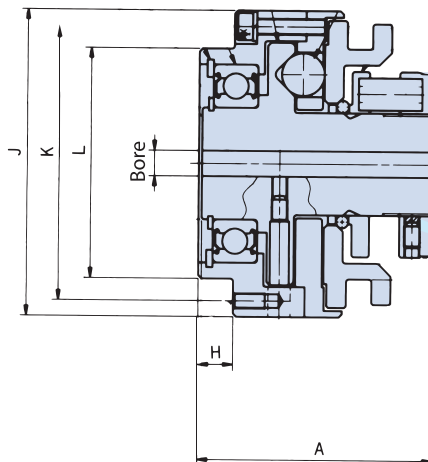

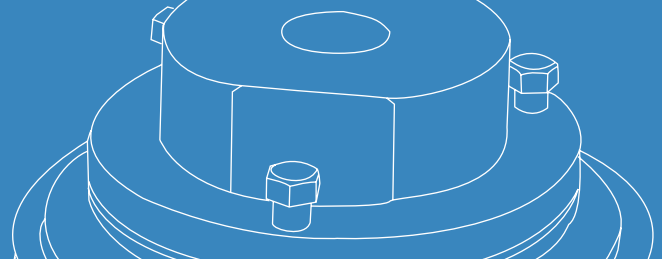

Torque Limiter

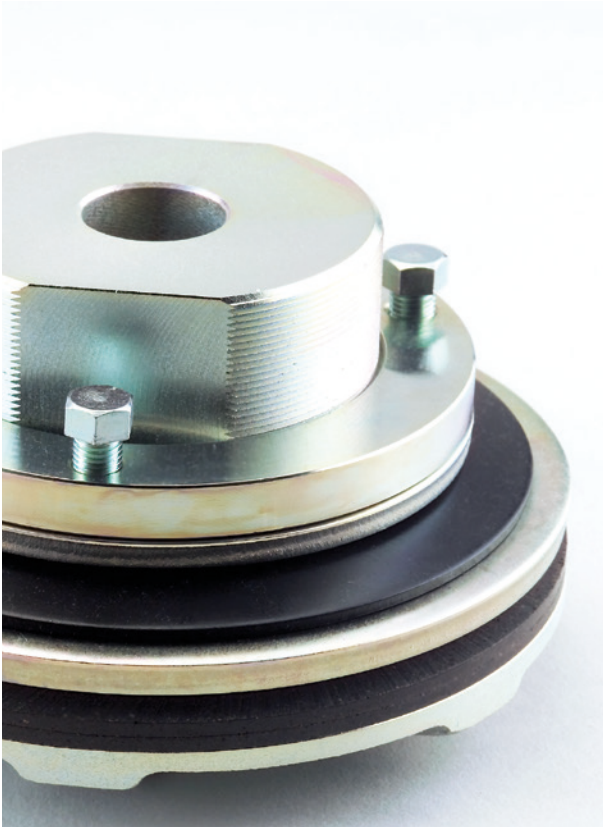

Environmentally safe, Tsubaki Torque Limiter contains no asbestos and no lead.

Torque Limiter can be used with a sprocket, sheave, or gear.

Tsubaki Torque Limiter's finer adjustment screw pitch means more precision.

Excellent for hard work and heavy use.

Refined by Tsubakimoto in Japan for over 40 years, the Torque Limiter is a simple and inexpensive mechanical device that, true to its name, limits damage to equipment when an unexpected increase in torque occurs because of a jam or overload.

Easy to install, the Torque Limiter attaches to a shaft and holds the drive or driven sprocket, gear, or sheave. A frictional system, the Torque Limiter reacts instantly when there is a jam by slipping and absorbing the brunt of the force, preventing the increased power from damaging your equipment.

Advantages over other devices:

- Competitively priced
- No resetting is required
- Adaptable to thousands of types of equipment configurations
- Can be used alone or in conjunction with other process controls.

INDUSTRY	APPLICATION
Material handling	Conveyors, turntables, elevators
Water treatment plants	Pumps, scrappers, water screens
Food machinery	Screw and belt conveyors, bucket elevators
Machine tool	Tapping machines, drill presses
Chemical	Pumps, agitators, filters

Not all Torque Limiters are created equally.

Tsubaki has developed a superior Torque Limiter that allows for more precise adjustments than other products of the same name. We accomplish this by using a finer-pitch thread on the adjustment bolts enabling accurate setting of the slip-point – no longer settle for just a ballpark value. Tsubaki Torque Limiters use specially-formulated friction materials to extend time between replacement and improve repeatability of the slip-point. Tsubaki Torque Limiters provide long life, consistent performance, and the best value over years of operation.

TL SERIES

Traditional machine protection. Friction-type construction. Slip-torque setting is done by simply tightening the adjusting nut or bolts. Competitively priced and easy to use.



SELECTION

Select based on torque required, rpm, and shaft diameter. Bushing Length selection should be equal to or shorter than width of center member (sprocket, etc.):

MODEL	TORQUE RANGE (LBS. - FT.)	MAXIMUM RPM	ROUGH STOCK BORE	MAX. BORE W.STD. KW	BUSHING LENGTHS	D	DH	L	S (MAX.)	WT (LBS.)
TL200-1L	0.7 ~ 1.5	1800	0.28	0.55	0.150, 0.236	2.0	0.95	1.14	0.276	0.44
TL200-1	2.2 ~ 7.2									
TL200-2	5.0 ~ 15									
TL250-1L	2.2 ~ 5.0	1800	0.39	0.88	0.177, 0.256	2.5	1.38	1.88	0.354	1.32
TL250-1	5.0 ~ 20									
TL250-2	10 ~ 40									
TL350-1L	7.0 ~ 15	1800	0.67	1.00	0.177, 0.256, 0.374	3.5	1.65	2.44	0.630	2.65
TL350-1	15 ~ 55									
TL350-2	25 ~ 110									
TL500-1L	15 ~ 36	1800	0.78	1.75	0.256, 0.374	5.0	2.56	3.0	0.630	7.72
TL500-1	35 ~ 155									
TL500-2	65 ~ 310									
TL700-1L	36 ~ 87	1800	1.18	2.63	0.374, 0.492	7.0	3.75	3.86	1.142	18.5
TL700-1	85 ~ 420									
TL700-2	165 ~ 800									
TL10-16	289 ~ 940	1000	1.18	2.84	0.492, 0.610, 0.768	10	3.94	4.53	0.945	46.3
TL10-24	435 ~ 1,370									
TL14-10	651 ~ 1,960	500	1.57	3.94	0.610, 0.768, 0.925	14	5.71	5.91	1.142	115
TL14-15	1,446 ~ 2,890									
TL20-6	1,807 ~ 3,615	500	1.97	5.12	0.610, 0.768, 0.925	20	7.28	6.89	1.22	258
TL20-12	3,400 ~ 6,870									

TORQUE LIMITER

TL200~TL350

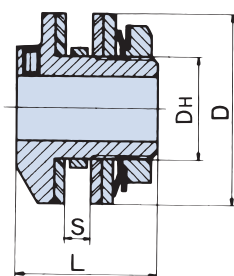

TL500~TL700

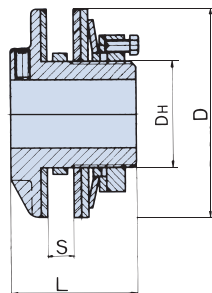

TL10~TL20

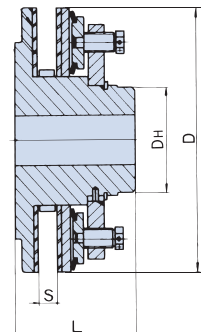

Axial Guard



Axial Guard is a new style of machine protection.

Axial Guard mounts directly to shaft.

Axial Guard provides immediate release when overload occurs.

Axial Guard addresses the difficult problem of straight-line operations.

Straight-line operations like pushers and cranks present unique challenges for determining and deflecting overload. Distinguished in the marketplace, U.S. Tsubaki's Axial Guard offers a new style of protection using ball and grooves that provide a consistent, repeatable, user-defined trip point.

Advantages over other devices:

- Highly-accurate repeatable trip point
- No parts to replace
- Easy installation using tapped end caps
- Load adjustment set with a single screw
- Non-backlash design allows a "rigid" installation

Axial Guard offers overload protection where motion is back and forth rather than rotating. This new-style mechanical protection device is easy to install and to adjust.

INDUSTRY	APPLICATION
Bulk handling	Conveyor torque arms, damper doors
Assembly equipment	Inserters, pick and place equipment
Metal-forming equipment	Extruders, formers
Packaging equipment	Carton sealing, labeling

Axial Guard works in either pushing or pulling applications – and the trip point in either direction is identical. When overloads occur, the Axial Guard "trips" and eliminates the overload that can result in damage and downtime. To reset, a small pull or push in the opposite direction is all it takes to return Tsubaki's Axial Guard to operation. Downtime has been limited and production is up and going quickly.

AXIAL GUARD

An all new mechanical-type overload device, the Axial Guard protects when the load acts linearly, as with pushers or cranks.

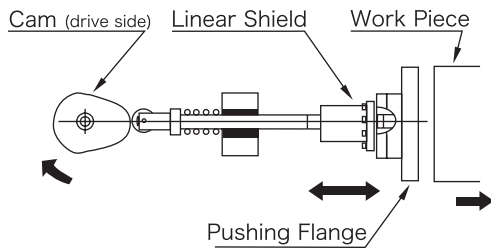

The cam pushes the work piece. When overload occurs due to the over-weighted work piece or jamming, the Axial Guard trips and protects the machine.



SELECTION

Select based on thrust load:

MODEL	THRUST LOAD RANGE (LBS.)	A	N	P	U	X	WT (LBS.)
TGA65	33 ~ 143	1.3	2.3	0.6	M6	M3	0.4
TGA150	132 ~ 330	1.5	2.8	0.8	M8	M4	0.9
TGA250	165 ~ 550	1.8	3.5	0.9	M12	M5	1.5
TGA350	220 ~ 770	2.2	4.3	1.2	M14	M6	2.6

LINEAR SHIELD

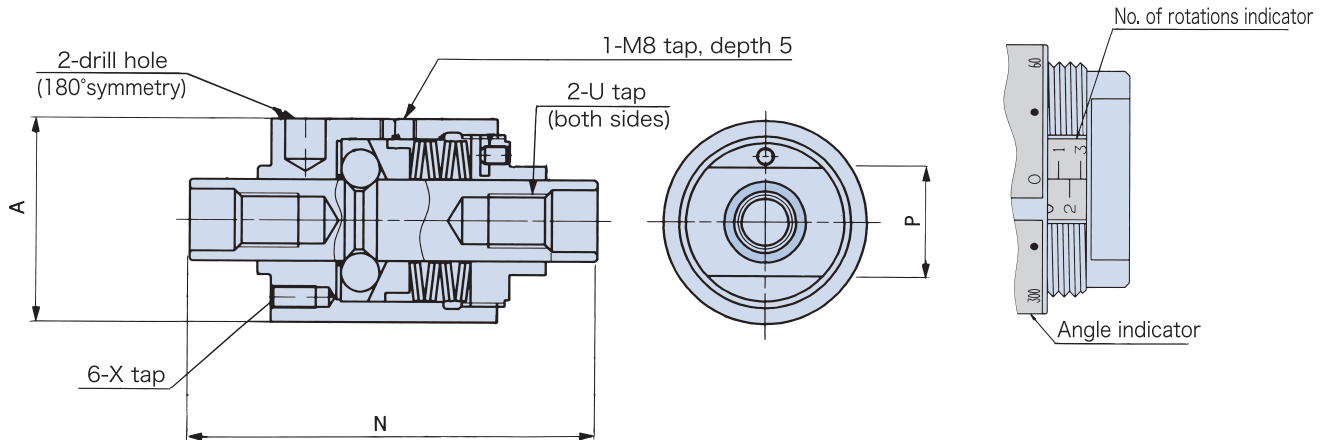

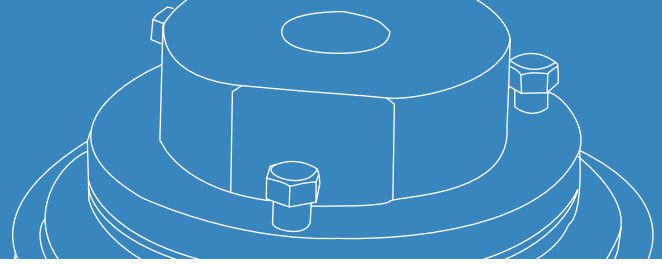

TORQUE LIMITER MACHINING GUIDELINES

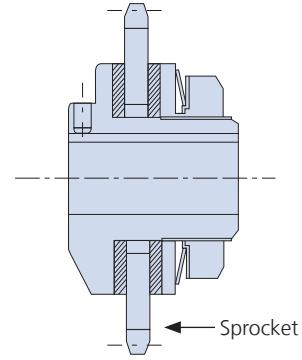

MINIMUM ROLLER CHAIN SPROCKET SIZE AND NUMBER OF TEETH

MODEL	RS35	RS40	RS50	RS60	RS80	RS100	RS120	RS140	RS160
TL200	20	16							
TL250		20	17						
TL350		26	21	18	15				
TL500			29	25	19				
TL700				33	26	21	16		
TL10						29	24	22	
TL14						39	33	29	26
TL20						54	46	40	35

CENTER MEMBER MACHINING TOLERANCES

MODEL	A MIN. DIA.	B BORE	C MAX	SURFACE FINISH- A&B
TL200	2.17	1.1811 ~ 1.1822	0.276	63 micro-inch finish max.
TL250	2.76	1.6141 ~ 1.6161	0.354	
TL350	3.74	1.9291 ~ 1.9311	0.630	
TL500	5.24	2.9133 ~ 2.9154	0.630	
TL700	7.25	4.1338 ~ 4.1358	1.142	
TL10	10.24	5.1349 ~ 5.3177	0.945	
TL14	14.25	7.2047 ~ 7.2075	1.142	
TL20	20.24	8.8976 ~ 8.9004	1.220	

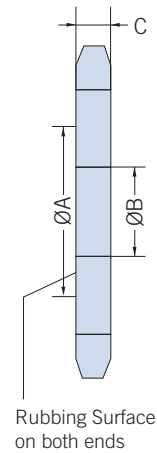

TORQUE LIMITER HUB MACHINING

Drawing illustrates hub held in machining center. Note machining values, H7 bore tolerances recommended.

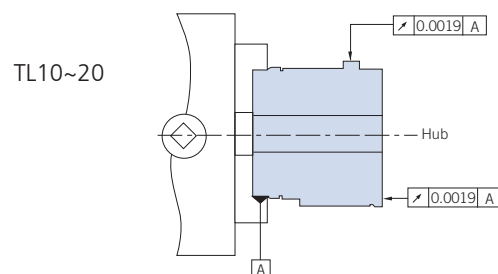
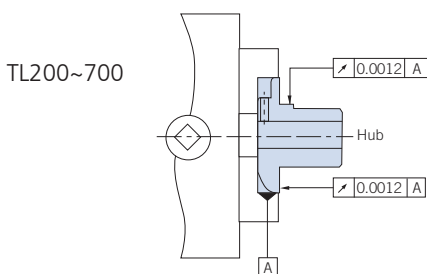

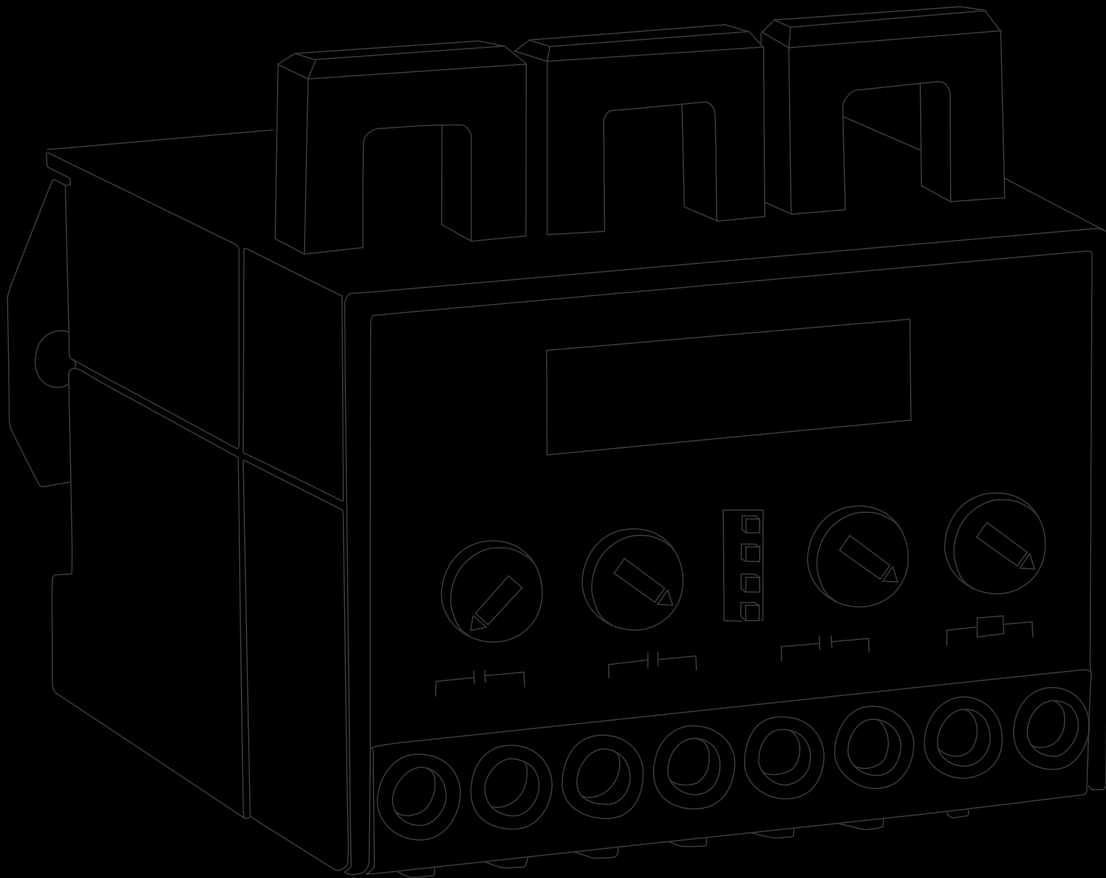

U. S. Tsubaki, Inc.

Headquarters

301 E. Marquardt Drive
 Wheeling, IL 60090
 Phone: (800) 323-7790
 Phone: (847) 459-9500
 Fax: (847) 459-9515

Roller Chain

Holyoke Plant

U. S. Tsubaki, Inc.
 821 Main Street
 Holyoke, MA 01040
 Phone: (800) 628-9037
 Fax: (413) 543-8239

Engineering Chain

Sandusky Plant

U. S. Tsubaki, Inc.
 1010 Edgewater Drive
 Sandusky, OH 44870
 Phone: (800) 537-6140
 Phone: (419) 626-4560
 Fax: (419) 626-5194

sales@ustsubaki.com
 ustsubaki.com



DISTRIBUTED BY:



NOTE: In accordance with the policy of U.S. Tsubaki, Inc. to consistently improve its products, the specifications in this catalog are subject to change without notice. © U.S. Tsubaki, Inc. 2008 All Rights Reserved.

CATALOGUE NUMBER: L0830000
 Printed in U.S. 3/08