



Power and Performance For the Mining Industry



Contents

TSUBAKI Profile

02-08

Tsubaki Spirit	02
Technology	03
Solution	05
Global Network	07

Surface Mining

09-26

Drill Rigs	11
Rotary Breakers	15
Feeder Breakers	17
Reclaimers	19
Coal Handling Prep Plants	21
Graders & Shovel / Excavators	25

Underground Mining

27-34

Shuttle Car	29
Face & Roof Drilling / Continuous Miner	33

Specialty Mining Products

35-66

Power-Lock®	37
Large Size Conveyor Chain	39
Sprockets	41
Cam Clutches Back Stops	51
Power Cylinders	57
Power Stations & Port Terminal Applications	61
Cable Carriers	65

The Tsubaki Spirit

As our business environment undergoes significant change, we have taken the opportunity presented by the commemoration of our 100th anniversary to reevaluate our company's purpose and what we identify as our goals. The result is a new Corporate Philosophy and Code of Conduct that apply to the entire Tsubaki Group, which we refer to as the "Tsubaki Spirit".

We also reviewed the "Tsubaki Group DNA", inherited from our predecessors, and identified the value that the Tsubaki Group will continue to offer the world in the future. We have clearly identified and systemized what we must cherish in the future and what challenges we should adopt as our social mission, aspiration, code of conduct, and founding philosophy.

For the Tsubaki Group to grow and continue to be a company that contributes to society in the coming 100 years, let's work together to ensure the Tsubaki Spirit remains inspirational to each Group employee, and is reflected in our day-to-day conduct.

*monozukuri: 'Mono(things)', 'Zukuri(making)' is a unique Japanese manufacturing style that embodies a state of mind or spirit to not only produce excellent products but also constantly improve the production system and its processes simultaneously.

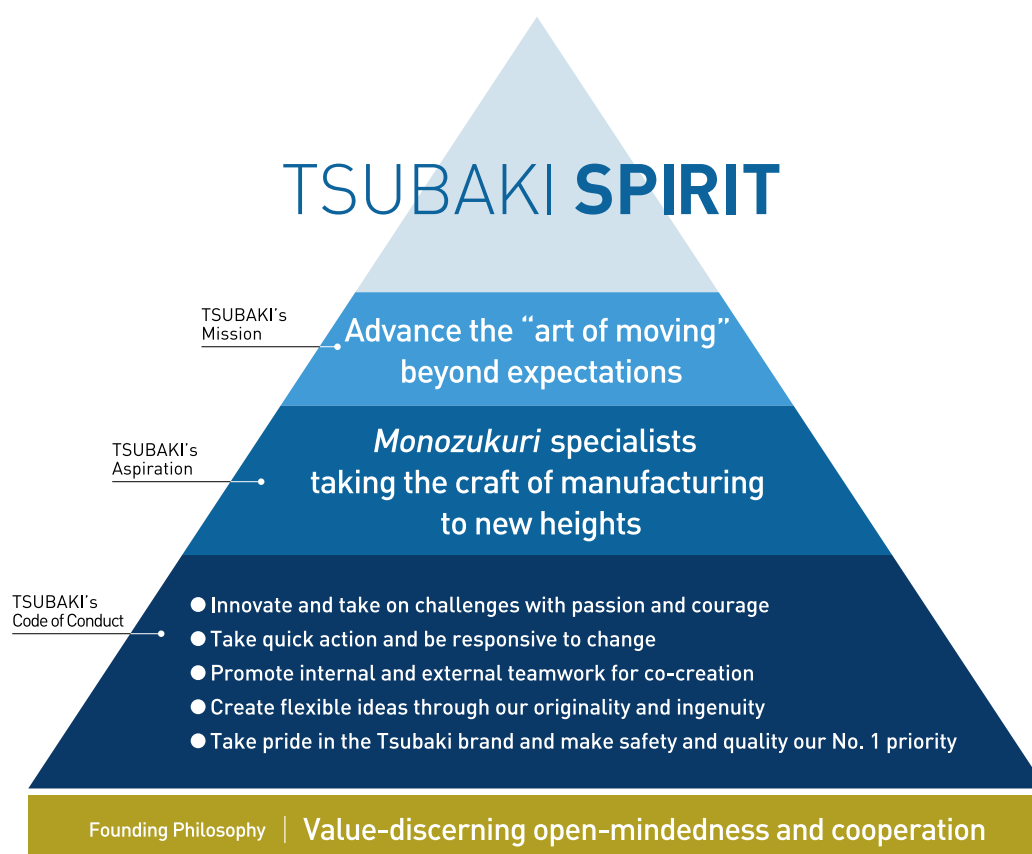

Tsubaki Technology



Kyotanabe Plant, Japan



Nagaokakyo Plant, Japan



Okayama Plant, Japan



Tsubakimoto Sprocket, Japan



US Tsubaki Sandusky Plant, U.S.A



US Tsubaki Holyoke Plant, U.S.A



Tsubaki of Canada Limited, Canada

Tsubaki Environmental Action Plan

Helping to create an environment in harmony with people and our planet. With its focus on manufacturing, Tsubaki takes a unique approach to the challenges of environmental conservation.

Principle

The Tsubaki Group believes that environmental conservation is a critical challenge facing humanity. We will remain mindful of the environment in all our operations and contribute to the world through our workmanship.

Environmental Policy

- We will acknowledge the environmental impact of our operations, products, and services.
- In the interests of environmental conservation, we will use our creativity to exhibit industry leadership in reducing our environmental load.
- We will create a management system for environmental conservation and will promote pollution control and continual improvement.
- We will strictly comply with environmental laws, rules, and regulations, and will seek to develop good relationships with our stakeholders.
- Through environmental training and in-house public relations, we will work to enhance awareness of environmental conservation among all Tsubaki Group employees.

Accredited with ISO 14001 Certification for Our Environmental Management System

- All Tsubaki Group workplaces in Japan are ISO 14001 certified; a growing number of Tsubaki Group workplaces outside Japan are doing so as well.

Ongoing Efforts to Reduce Our Environmental Impact

- We are reducing CO₂ emissions resulting from our energy consumption.
- We are implementing recycling and waste-reduction initiatives.

Ensuring Strict Compliance with Environmental Laws and Regulations

- We are instituting management systems at all our workplaces to ensure full compliance with local laws and regulations.

Products for the Environmental Market

Water Treatment Facilities and Equipment

Our sewage treatment facilities and equipment help maintain the water quality in water treatment facilities throughout Japan.

Conveyors for the Environmental Market

Our conveyance devices for environmental facilities are used in applications such as waste incineration and processing of industrial waste, household refuse, and sludge. And with equipment provided by Tsubakimoto Bulk Systems Corporation and Tsubakimoto Mayfran Inc., we provide metal conveyance and coolant processing equipment for metal machining and processing applications. Clearly, our conveyor products are meeting the needs of the environmental market.



Reducing CO₂ emissions with a highly efficient cogeneration system.



This heat exchange system cools our injection molding equipment with heat from an electrical generator.



NEPTUNE Chain®

Tsubaki Solution

Power and Performance For the Mining Industry

All of the products in the power transmission and materials handling fields were originally conceived as solutions for our customers.

If you have concerns about improving productivity or developing competitive products, come and talk it over with us.

We have developed the systems and components below by listening to our customers and customizing our technologies.

In response to increasingly pressing environmental preservation issues and the need for further IT integration, speed, and cost reduction, we will apply our advanced mechatronics technology and systems development capability to provide your company with the best solution. Let's work together on solving your next problem.

Tsubakimoto Chain

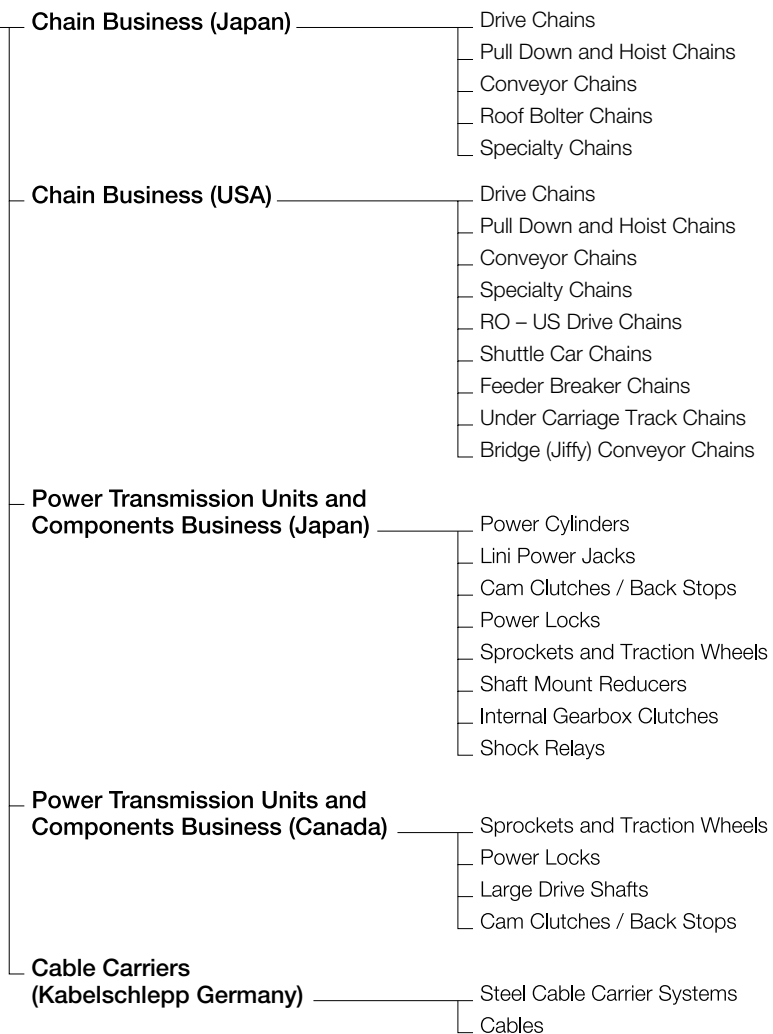



Segmental Rim Sprocket

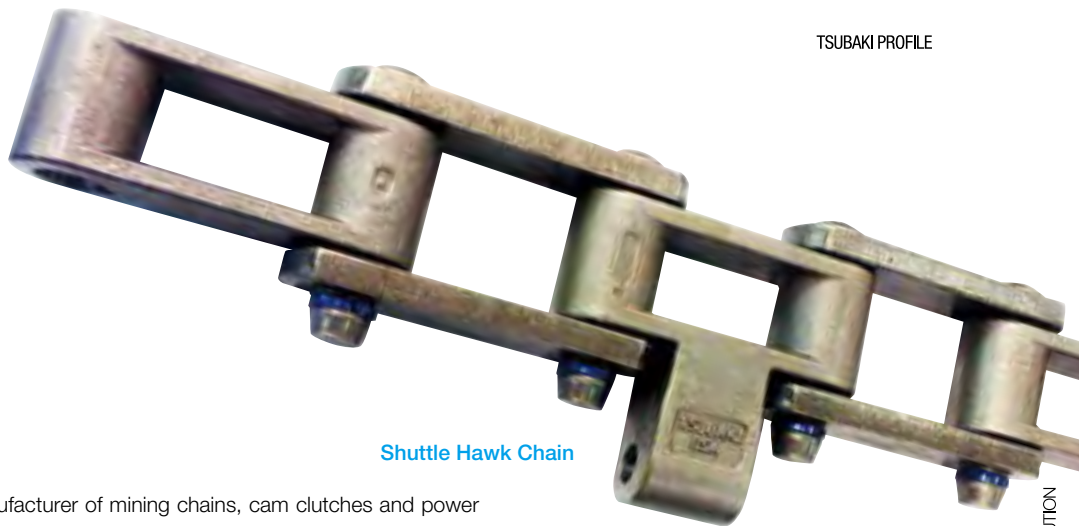

Shuttle Hawk Chain

Mining with Tsubaki

The Tsubaki Group is the leading manufacturer of mining chains, cam clutches and power cylinders used in underground mines, above ground mines, preparation plants, power stations and port facility applications.

We currently manufacture many different sizes of mining chains for several major OEMs. These relationships enable us to design upgrades for the chain in mining equipment to meet the ever-changing needs of the industry.

We use alloy-grade steels, heat-treated to precise specifications and assembled with heavy press-fits required to withstand the punishment of today's more powerful, high production mining equipment.

Our complete line of mining chains include Shuttle Car Chain, Feeder Breaker Chain, as well as various chains widely used in drill rigs, rotary breakers, reclaimers, face/roof drilling, continuous miners, prep plants, roof support machines, and continuous haulage systems.

The Tsubaki Group is also proud to provide a wide variety of in-house designed sprockets, which are required in all chain applications, as well as other related products such as our highly reliable and strictly tested Cam Clutches, Power Cylinders and Power Locks.

Furthermore, as the Tsubaki Group prides itself on its ability to answer customers' demanding needs through innovative customization of its products, we are able to manufacture made-to-order chains and attachment configurations, sprockets, etc., for your individual requirements. Please contact your local Tsubaki representative for further details.



Feeder Breaker Chain



BS-F Series Backstop clutch

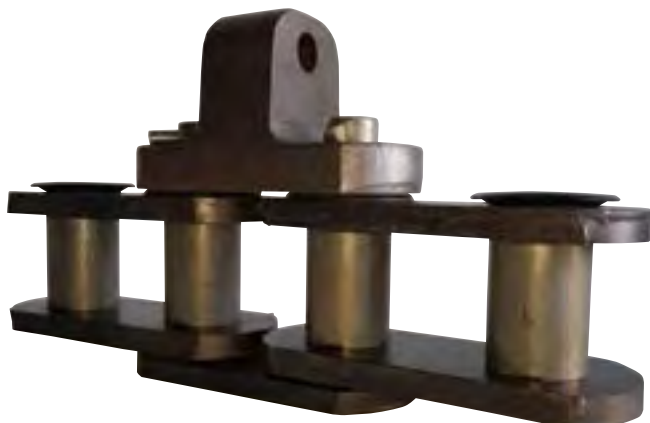

Feeder Breaker Chain



Lambda® Chain

Tsubaki Global Network



U.S.Tsubaki, Inc. (UST)

Wherever you are in the world, our production and sales network is able to provide your business with the immediate support it needs.

A manufacturing infrastructure that lets you forget international borders – the large scale on which Tsubaki’s services operate makes sure your global business ventures are successful. Through Group companies worldwide, we will deliver full back-up and rapid response to your local needs anywhere on the globe.

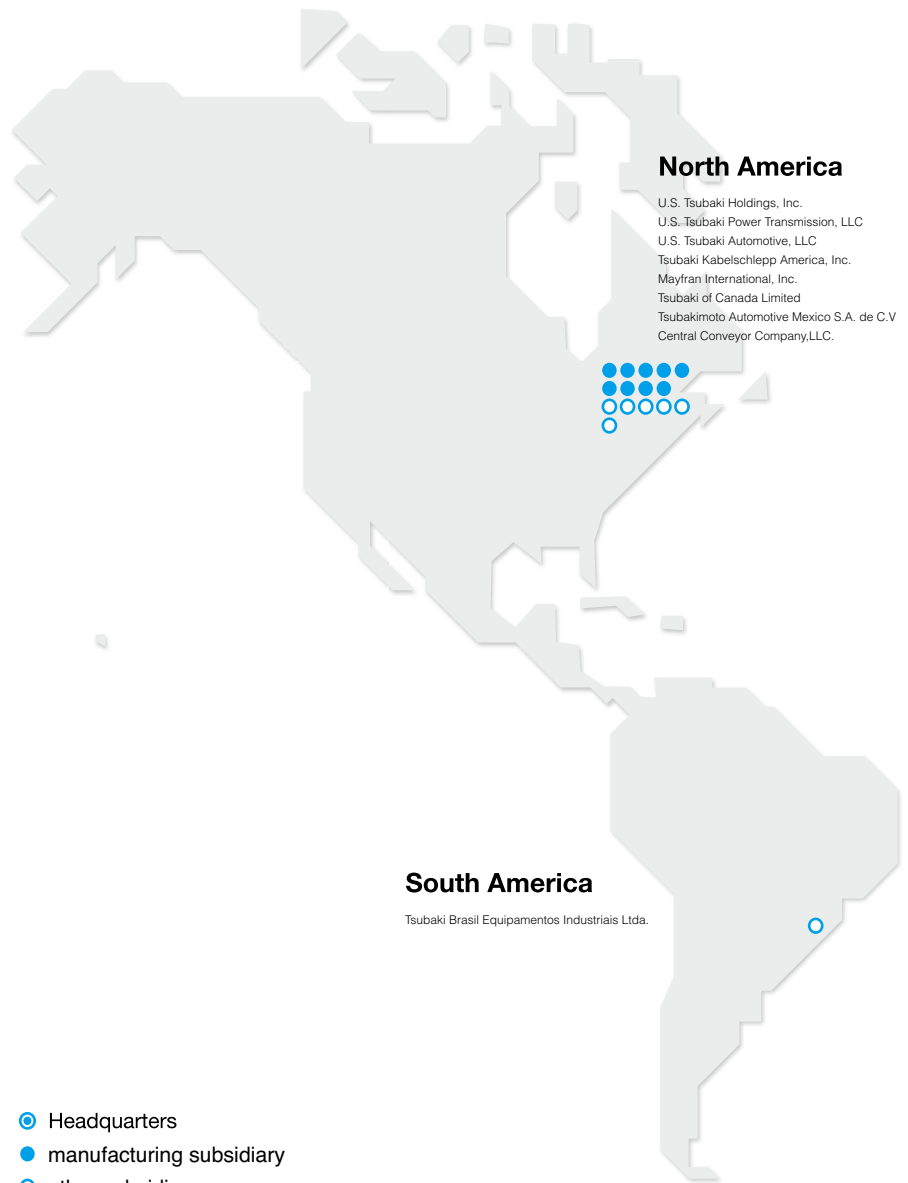

* Please contact your local Tsubaki representative for details on a distributor near you.



US Tsubaki Portland Plant



US Tsubaki Holyoke Plant



US Tsubaki Sandusky Plant



US Tsubaki Chicopee Plant



Tsubaki of Canada Limited

Tsubakimoto Europe B.V.

Korea Conveyor Ind. Co., Ltd.

Tsubakimoto Automotive (Shanghai) Co., Ltd.

Europe

- Tsubakimoto Europe B.V.
- Mayfran Limburg B.V.
- Mayfran International B.V.
- Tsubaki Kableschlepp GmbH
- Tsubaki Ibérica Power Transmission S.L.
- Tsubaki Deutschland GmbH
- Kableschlepp GmbH-Hünsborn
- Tsubakimoto U.K. Ltd.
- Kableschlepp France S.A.R.L.
- Mayfran France S.A.R.L.
- Kableschlepp Italia S.R.L.
- Tsubaki Automotive Czech Republic s.r.o.
- Kableschlepp Systemtechnik spol. s.r.o.
- OOO Tsubaki Kableschlepp

China

- Tsubakimoto Automotive (Shanghai) Co., Ltd.
- Tsubakimoto Chain (Shanghai) Co., Ltd.
- Tsubaki Motion Control (Shanghai) Co., Ltd.
- Tsubakimoto Bulk Systems (Shanghai) Corp.
- Tsubakimoto Chain Engineering (Shanghai) Co., Ltd.
- Tsubakimoto Chain (Tianjin) Co., Ltd.
- Tsubaki Everbest Gear (Tianjin) Co., Ltd.
- Kableschlepp China Co., Ltd.
- Tianjin Tsubakimoto Conveyor Systems Co., Ltd.
- Tsubaki CAPT Power Transmission (Shijiazhuang) Co., Ltd.

Japan

- Tsubakimoto Custom Chain Co.
- Tsubakimoto Sprocket Co.
- Tsubaki Yamakyu Chain Co.
- Tsubakimoto Iron Casting Co.
- Tsubakimoto Bulk Systems Corp.
- Tsubakimoto Mayfran Inc.
- Tsubakimoto Machinery Co.
- Tsubaki Support Center Co.

South Korea and Taiwan

- Taiwan Tsubakimoto Co.
- Tsubakimoto Automotive Korea Co., Ltd.
- Tsubakimoto Korea Co., Ltd.

Indian Ocean Rim

- Tsubakimoto Singapore Pte. Ltd.
- PT. Tsubaki Indonesia Manufacturing
- PT. Tsubaki Indonesia Trading
- Tsubakimoto (Thailand) Co., Ltd.
- Tsubakimoto Automotive (Thailand) Co., Ltd.
- Tsubaki Motion Control (Thailand) Co., Ltd.
- Tsubaki Power Transmission (Malaysia) Sdn. Bhd.
- Tsubakimoto Vietnam Co., Ltd.
- Tsubakimoto Philippines Corporation
- Tsubaki India Power Transmission Private Limited
- Kableschlepp India Private Limited
- Mahindra Tsubaki Conveyor Systems Private Limited

Australia

- Tsubaki Australia Pty. Limited
- Head Office / Sydney Sales Office
- Brisbane Sales Office
- Melbourne Sales Office
- Perth Sales Office
- New Zealand Branch Office

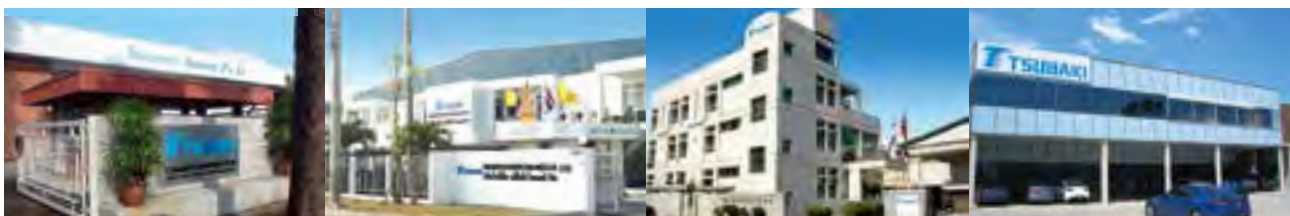

Tsubakimoto Singapore Pte. Ltd.

Tsubakimoto Automotive (Thailand) Co., Ltd.

Taiwan Tsubakimoto Co.

Tsubaki Australia Pty. Limited



To access profitable material deposits located near the surface, heavy machinery and blasting techniques are used to remove overburden soil and rock which would normally impede extraction of materials. Depending on the material extracted, the ore or raw mineral is conveyed to a processing plant where it is either washed, beneficiated, concentrated or refined to achieve the saleable product.

As the extraction and processing of the raw material is done in the most demanding of environments, components on the machinery used need to excel in these conditions. For these applications Tsubaki offers a wide variety of tried and tested heavy duty roller chains, conveyor chains, reclaimer chains, engineering class sprockets, back stops, electric actuators and protection devices for use on equipment or in plants such as :

- Drill Rigs
- Feeder Breakers
- Rotary Breakers
- Shovels
- Diverter Chutes
- Coal Port Loading Facilities
- Bucket Wheel Reclaimers
- Drag Lines
- Rail Loading Stations
- Wash Plants
- Refineries
- Smelters
- Conveyors
- "A" Portal Reclaimers

1 DRILL RIGS

G8 Series Heavy Duty Roller Chains (Pg.12), APP Specification (Pg.13), Super Long Length Formation for Large Size Roller Chain (Pg.14) Sprockets (Pg.42), Kabelschlepp Products (Pg.66)

2 ROTARY BREAKERS

Heavy Duty Drive Chain (Pg.16), Sprockets (Pg.42) Power Locks (Pg.38)

3 FEEDER BREAKERS

Feeder Breaker Chain (Pg.18), Special Corrosion Resistant Surface Treatment (Pg.18), Sprockets (Pg.42), Heavy Duty Drive Chain (Pg.16)

4 RECLAIMERS

Stacker Reclaimer Chain (Pg.20), Sprockets (Pg.42), Kabelschlepp Products (Pg.66)

5 CHPP

RS Roller Chain G8 (Pg.22), LAMBDA Chain (Pg.23), Specialty Chains (Pg.20)

6 ROAD GRADERS

G8 Series Heavy Duty Roller Chains (Pg.12), Sprockets (Pg.42)

7 MINING SHOVEL

Heavy Duty Drive Chain (Pg.16), RS Roller Chain G8 (Pg.22)

8 STACKER

Cam Clutch, Back Stop (Pg.52)

9 BUCKET WHEEL RECLAIMER

Heavy Duty Drive Chain (Pg.16), Cam Clutch (Pg.52), Kabelschlepp Products (Pg.66)

10 HOPPER BIN

Power Cylinder (Pg.58)

11 STOCK PILE CONVEYOR

Cam Clutch (Pg.32), Power Cylinder (Pg.58), RS Roller Chain G8 (Pg.22)

12 INCLINE CONVEYORS

Cam Clutches / Back Stops (Pg.52), Power Locks (Pg.38), Power Cylinders (Pg.58)

Surface Mining

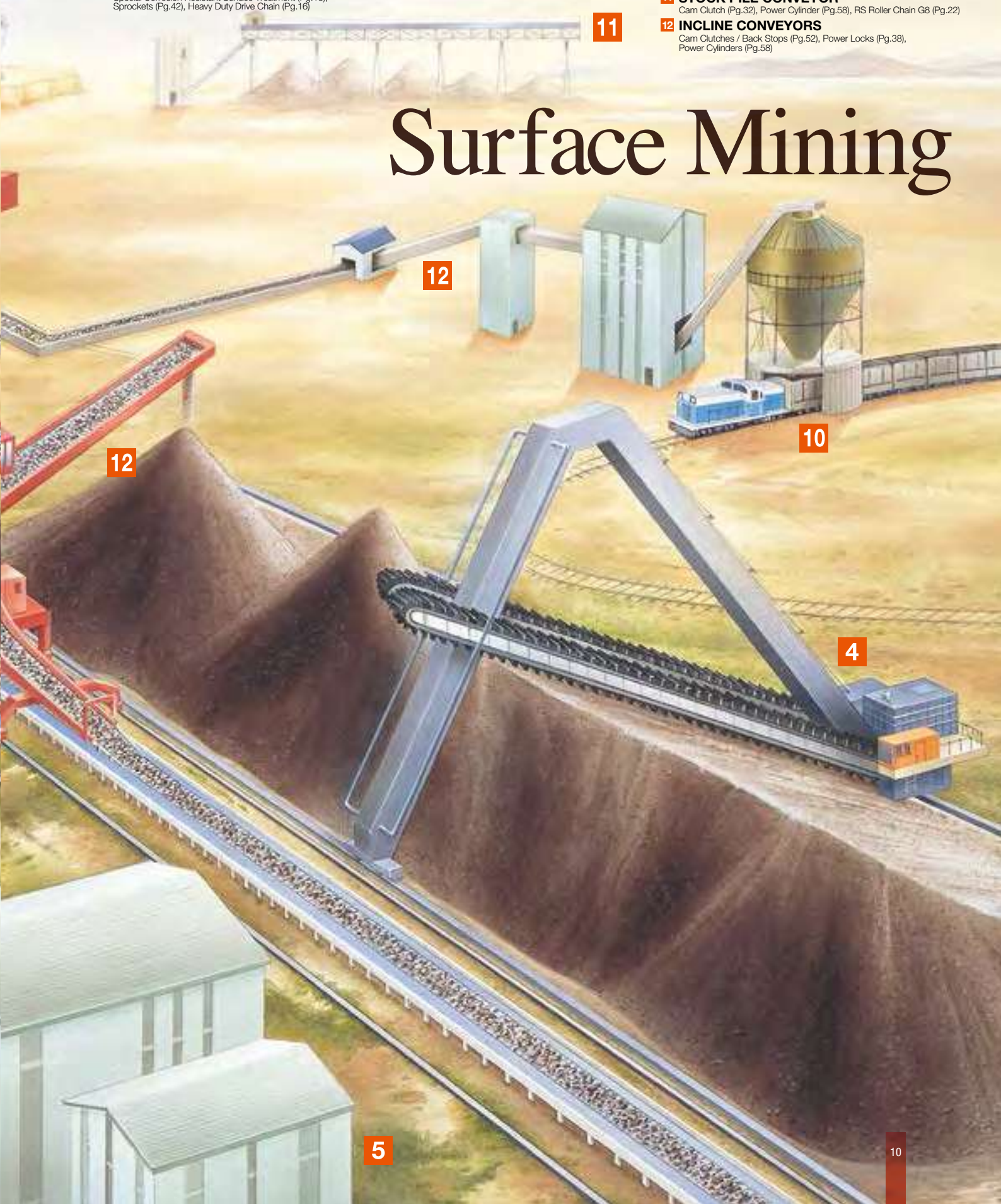

Drill Rigs

Drill rigs create deep surface holes which are then filled with explosives and blasted to allow for the removal of the overburden. Other applications include extracting core samples for exploration purposes. To overcome the heavy shock loads associated with this type of drilling, Tsubaki offers the G8 Series Heavy Duty Roller Chains: RS-HT Chain, Super Chain and Super-H Chain. To protect against pitting corrosion, Tsubaki offers APP surface treatment, which is highly effective in outdoor environments. To help create a safer work environment, Tsubaki provides Super Long Length Formation for Large Size Roller Chain, allowing for a continuous length chain void of any connecting links in the entire length of the chain.



G8 Series Heavy Duty Roller Chains



ANSI standard roller chains are widely used in various industries. To meet growing industry demands for cost efficiency, stronger and higher performing chains which can replace the corresponding ANSI standard chains are necessary. Tsubaki offers a line of Heavy Duty Roller Chains to solve your specific problems associated with heavy shock loads and other operating issues.

RS-HT Chain

The outer and inner plates are one size thicker than on RS Roller Chains.

RS-HT Chain has 20% greater tensile strength than RS Roller Chain, and so is ideal for applications requiring high tensile strength and low elastic elongation.

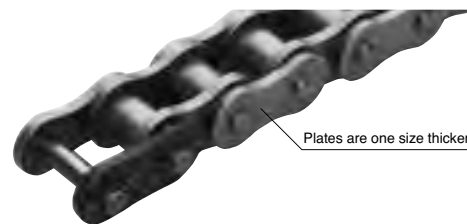
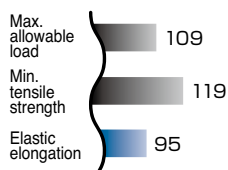

HT Series

Super Chain

Super Chain has the same three basic dimensions of RS Roller Chain, but it has a thicker waist that provides a 40% increase in maximum allowable load over RS Roller Chain. Suitable for situations where RS Roller Chain would suffer fatigue breakage, or allows users to select a chain one size down.

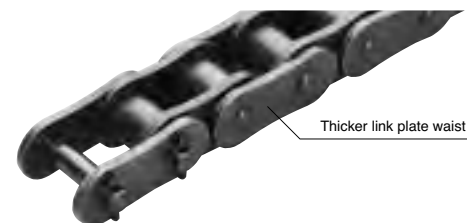
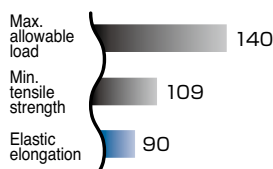

Super Series

Super-H Chain

Features inner and outer link plates shaped the same way as Super Chain that are one size thicker than RS Roller Chain. This gives Super-H Chains a higher allowable load and fatigue strength for applications requiring shock absorption.

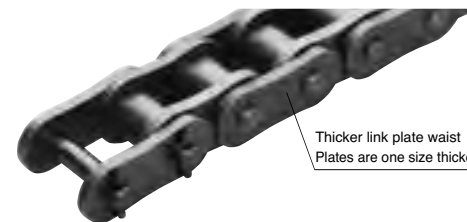
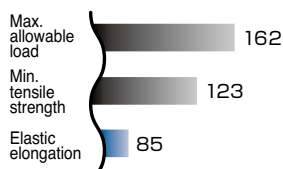

Super-H Series

*The values in each graph are shown in relation to standard roller chain with a benchmark of 100. (Comparison with RS80.)

Tsubaki Super Chain Series Features

Note : With RS Roller Chain mim. tensile strength and max. allowable load as benchmark (100).

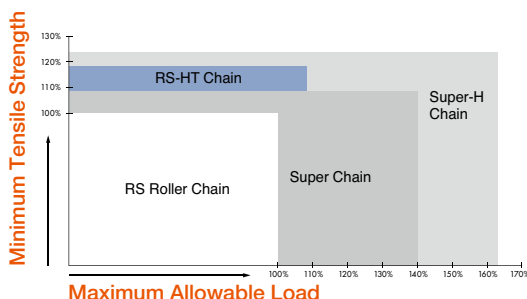

If you experience had problems such as fatigue breakage of link plates, or generally poor performance, we recommend that you try the Tsubaki RS-HT Chain, Super Chain or Super-H Chain where you can dramatically increase the strength of your chain without having to make major modifications to your existing equipment.

Drilling Machine

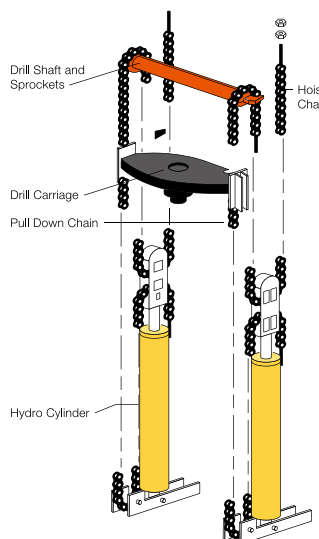

Corrosion Resistant and Surface-Treated Drive Chains APP Series

Outstanding performance in atmospheres conducive to pitting corrosion.

Pins are treated with a special surface treatment to protect against pitting corrosion that leads to fatigue breaks, thus preventing strength loss. This treatment is highly effective in environments that readily promote corrosion, such as outdoor or coastal applications.

Note: Pitting is a type of localized corrosion affecting metal surfaces. Pits form toward the interior, and if pitting occurs on pin surfaces, that pin can quickly lead to fatigue breakage and chain failure.



Features

No strength loss!

Same as Tsubaki standard steel chain.

Eco-friendly chrome-free!

Special surface treatment does not use hazardous hexavalent chromium.

Example Applications

APP Chains are ideal for atmospheres that readily promote corrosion.

- Outdoor uses
- Coastal or riverside uses
- When regular lubrication is difficult

Because equipment is used outdoors, rain can infiltrate equipment, creating conditions that promote pitting corrosion. Also, pitting readily occurs in equipment exposed to salty air or saltwater spray.

Example of fatigue breaks caused by pitting corrosion

Chain: #160 Duplex

Equipment: Drill Rig

Pitting corrosion of the pin due to insufficient lubrication and corrosive atmosphere = Fatigue breakage



Available for

Single/Double Strand
RS Roller Chain

Except for the surface-treated pins, dimensions and other specifications are the same as other roller chains.

Single Strand
Heavy Duty Roller Chain

(For other models, contact Tsubaki.)

Super Long Length Formation for Large Size Roller Chain

Removes the hassle of connecting chain for the user and contributes to a safe work environment.

As chain size increases, so does the burden of connecting it for the user. By connecting and delivering chains of the desired longer length, we can increase your work productivity and help maintain a safe working environment.

Safer

The entire chain is connected, meaning no connection work for the user and more stable product quality.

Simpler

The chain is delivered folded over itself in a special made wooden box for easy removal.

- * Tsubaki can supply wooden boxes using treated materials for exports. (Complies with ISPM Guidelines.)
- * Case mark for export can also be affixed to the box.
- * Box is delivered horizontally. Box must stand upright to lift out chains.

More Reliable

Reliable installation - No more worries about on-site connection or twisting.

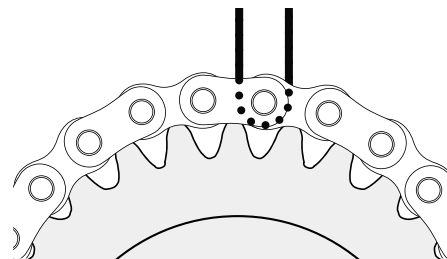
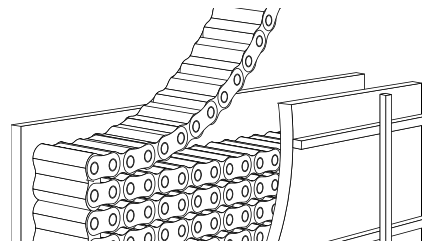
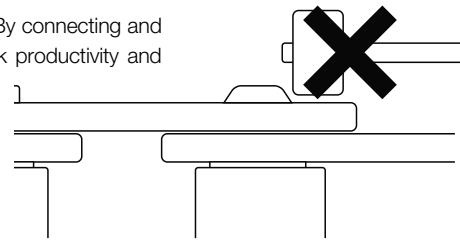

RS TOUGH TOOTH Sprockets

Tough Tooth sprockets have increased strength and durability to bring out the best in Tsubaki's new G8 Series Heavy Duty Drive Chains.

Features

- Teeth have ample strength to handle the increased strength of the G8 Series Heavy Duty Chain. The hub has been further strengthened as well.
- All models feature hardened teeth to give the sprocket more wear resistance.
- A special coating that even further increases tooth hardness is also available (optional). Ideal for harsh operating environments where users want to reduce chain and sprocket replacement frequency. The coating has a Vickers hardness over 800 to give the sprocket more wear resistance.

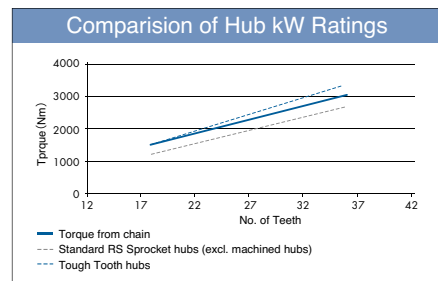
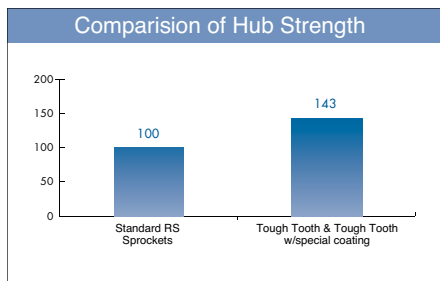

Note: 1. Torque is calculated from keyway allowable surface pressure using a JIS parallel key at the maximum shaft hub diameter.
2. Comparison using RS80-SUP-H-1.

Specifications

- B and C types standardized for single and double strand RS-HT Series RS60 and above.
- RS-HT Chains and Super-H Chains in multi strand configurations have a different tooth transverse pitch than RS Roller Chain sprockets.
- Other multi strand configurations, hub types, and numbers of teeth are made-to-order. Other shaft hub finishing also available.
- Both teeth and hubs use carbon steel for machine structural use.
- Made-to-order product.

User Connects

User Connects

Before...

Chain over 10m long can be delivered already connected!

DRILL RIGS

BUT NOW!

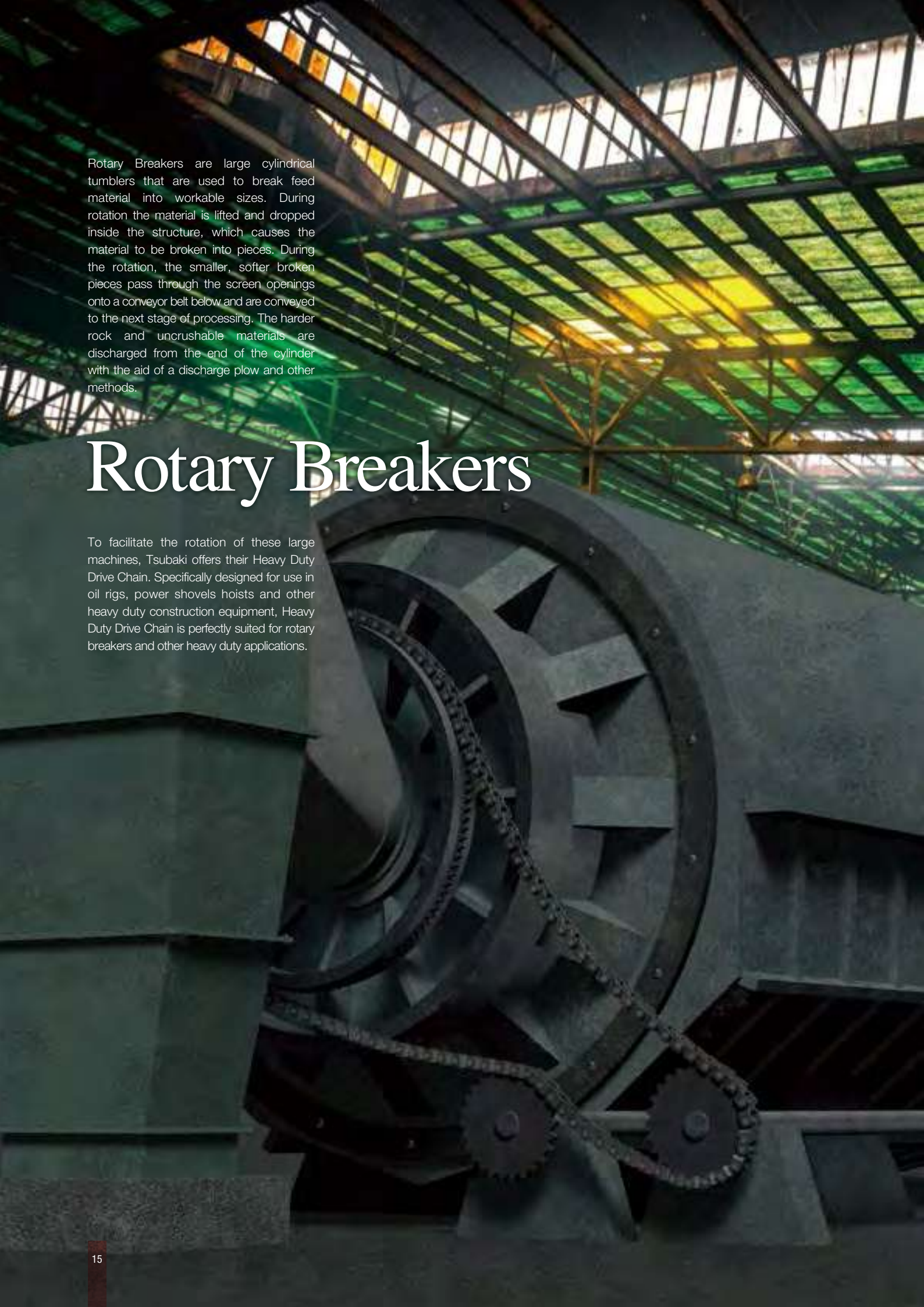

Rotary Breakers are large cylindrical tumblers that are used to break feed material into workable sizes. During rotation the material is lifted and dropped inside the structure, which causes the material to be broken into pieces. During the rotation, the smaller, softer broken pieces pass through the screen openings onto a conveyor belt below and are conveyed to the next stage of processing. The harder rock and uncrushable materials are discharged from the end of the cylinder with the aid of a discharge plow and other methods.

Rotary Breakers

To facilitate the rotation of these large machines, Tsubaki offers their Heavy Duty Drive Chain. Specifically designed for use in oil rigs, power shovels hoists and other heavy duty construction equipment, Heavy Duty Drive Chain is perfectly suited for rotary breakers and other heavy duty applications.

Tsubaki Heavy Duty Drive Chain

Keep Your Operation Moving with Tsubaki Heavy Duty Drive Chain

Tsubaki Heavy Duty Drive Chain is designed to exceed the listed ultimate strength ratings. These ratings are very significant. Chains with greater ultimate strength have higher actual yield and greater fatigue strength. With Tsubaki Heavy Duty Drive Chain, you get extra reserve strength to withstand high shock loads.

Precision Manufacturing Means Greater Fatigue Strength

Tsubaki Heavy Duty Drive Chain is built to withstand the most rugged conditions. We use the latest manufacturing and heat-treatment techniques to manufacture every component. Each component is carefully machined to close tolerances to ensure precise pitch control for smooth sprocket/chain interaction. That means longer service life for chain and sprockets.

Add the Power of Alloy

When parts require extra hardness, we use alloy steel to make the components. This provides more uniform core strength, which is particularly important for heavy duty applications. Every Tsubaki Heavy Duty Drive Chain with an ultimate strength rating higher than 50802.35kg (112,000 pounds) is made entirely of alloy steel. All Tsubaki Heavy Duty Drive Chains are furnished with alloy steel pins.

Reduced Maintenance Costs and Downtime

Tsubaki Heavy Duty Drive Chain stands up to the toughest environments for hour after hour of uninterrupted service.

- Optimum strength
- Fatigue resistant
- Pre-tested
- Alloy steel parts
- Press fit construction
- Accurate pitch control

Heavy Duty Drive Chain Produced by U.S. Tsubaki

Sprockets and Thrust Rollers

Rotary breaker sprockets and thrust rollers are subjected to the highest load demands. The operating parameters for these components demand the most stringent level of engineering and machining know-how.

Tsubaki sprocket and thrust roller components are designed to exacting standards and the highest safety factor ratings to ensure optimal operating performance.

Your equipment is on the line. Count on Tsubaki Heavy Duty Drive Chain.



Special Features

- Grease nipple pins
- Special pin coatings
- Stainless steel pins

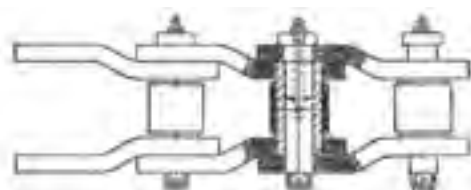
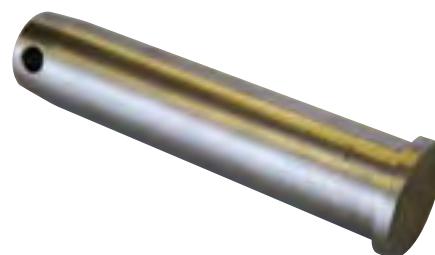



Feeder Breakers are primary crushers designed to break ore into smaller sizes via a deck and chain conveyor system. The chain conveyor feeds the crushed ore onto belt conveyors where it is sent for further processing or stockpiling.

Feeder Breakers

For the conveyor mechanism, Tsubaki offers our proven Feeder Breaker (Steel Bushed) conveyor chain and flight bars for this application. Sizes include 88.9mm (3.5"), 76.2mm x 101.6mm (3" x 4"), 114.3mm (4.5"), 139.7mm (5.5"), 152.4mm (6"), or we can custom make a size suitable for most applications.

Also, to help overcome rapid wear from the severe working environments found in the mining industry, Tsubaki is also proud to provide its industry-proven corrosion resistant surface treatment, greatly extending a chain's wear life in even the harshest of conditions.

Feeder Breaker Chain (Steel Bushed Chain)

Tsubaki Feeder Breaker Chains (also known as Steel Bushed Chains) are specially designed and manufactured to provide excellent service in severe working conditions. Our chains are manufactured to close tolerances with the most modern equipment in the industry. Each component is made from high-quality alloy steels (pins are made of select alloy steel or high-quality carbon steel) and then specially heat-treated to provide maximum performance and long wear life. Joint parts are hardened to provide greater strength and wear resistance. Link plates are hardened to achieve ultra-high strength throughout.

Available Sizes	
88.9mm (3.5")	139.7mm (5.5")
76.2mm × 101.6mm (3" × 4")	152.4mm (6")
114.3mm (4.5")	Custom sizes also available

Feeder Breaker Chain Components & Features

Strong, Tough Pins

Pins are hardened to achieve superior strength and extend wear life. This creates the ideal combination of surface hardness for wear resistance and core toughness to resist impact.

Long-Lasting Bushes

Bushes are manufactured to rigid specifications for optimum wear resistance and strength. Select steels are precision machined to maintain consistently high link plate interference. This results in positive link plate hold and favorable residual stress to resist fatigue. Bushes are case-hardened and heat-treated to extend wear life.

Fatigue-Resistant Link Plates

Link plates are through hardened to achieve ultra-high strength. This keeps the chain running failure-free, ensuring consistent service life. Tsubaki has developed superior techniques to ensure hole quality and pitch control. The result is fatigue resistance and premium performance.

Sealed Joint Chains

Tsubaki has developed a special triple sealing arrangement for the bearing areas of the chain. The incorporation of pin and bush greasing and precision chain assembly all play a part in the increased life this chain can offer in moist or heavy dust environments.

Feeder Breaker Chain is produced by U.S. Tsubaki.

Corrosion Resistant Surface Treatment Technology

Combining the proven strength of alloy steel with superior corrosion resistance, Tsubaki's special corrosive resistant surface treatments deliver significantly extended service life for reduced total operating costs. Tsubaki offers a complete corrosion resistant package for roller chain, engineering chain and sprockets.

If your drive or conveyor chains are exposed to intermittent water, occasional wash-downs, outdoor conditions, or even chemicals and salt water, your chains and sprockets need to be surface treated to keep your equipment moving.

The advanced performance of Tsubaki's corrosion resistant surface treatments is the result of a revolutionary mechanical plating system treatment. It protects the chain and extends its service life by resisting corrosion longer than ever before.

Tsubaki G8 series NEPTUNE chain is a surface treated chain that uses a RS Roller Chain with a special coating and top coating. NEPTUNE Chain is a highly durable chain that offers superb saltwater, weather, chemical and comprehensive corrosion resistance.

It uses no harmful chromium, instead using revolutionary eco-friendly surface treatment technology.

Corrosion eats up more than chain — it eats up your profits! Choose strong, long-lasting corrosion resistant surface treatment and protect your bottom line. For more information, please contact your local Tsubaki representative.

*Note on usage: Contact a Tsubaki representative when using in high temperature steam environments.



In-house Salt Spray Test Results



Tsubaki NEPTUNE:
700H NO RUST



Company A: 400H



Company B: 200H



Company C: 300H



Reclaimers

Designed to transfer the coal stock pile to the Coal Handling Pre-Plant (CHPP) or to the Coal Loading Facility, these machines are critical to any CHPP. Demands for product availability and higher feed rates require the power transmission components to exceed the industry standards now and into the future.

Operating conditions like this require the best in design and innovation, and Tsubaki is the proven name in the field for delivery on performance and increased profitability.

For these machines, Tsubaki has designed a made-to-order Stacker Reclaimer Chain. With a wide variety of options, these chains are specifically designed and manufactured to meet the unique challenges of your operation. To help battle against potential dust build up between bushes and rollers, Tsubaki is proud to introduce the improved anti-dust capabilities for the Bearing Roller Conveyor Chain. Also widely utilized are Tsubaki's highly customizable Large Size Conveyor Chains. With a wide variety of base materials, corrosion resistant coatings, attachments and rollers available, Tsubaki is confident we have a Large Size Conveyor Chain that can meet the unique challenges of your mining site.

Stacker Reclaimer Chain



Stacker Reclaimers are popular when heavy industrial processes require large stockpiles of raw material. Reclaimer chain and flight assemblies function like scraper conveyors, less the trough, with flight blades that push material toward a belt feeding conveyor. The reclaimer conveyor's chain with digging flights is supported by rails and structure which span over or across the pile being reclaimed for transfer to plant processes.

Chain for this demanding application should provide the longest service life to achieve the best overall value. Chain must have large bearing areas, high hardness and deep case depth to provide the best performance. Tsubaki engineers have used these principles while retrofitting many reclaiming conveyors with chain and sprockets, achieving longer service life than OEM chains. For superior value and performance, Tsubaki chain is your best choice.

Note that due to their complex requirements, reclaimer chains are normally manufactured on a made-to-order basis, designed and manufactured to meet the specific unique requirements of each site. Please contact your local Tsubaki representative to obtain certified prints for design and construction.

Improved Dust Resistance

Outboard Roller Conveyor Chain with a Labyrinth Construction

Tsubaki developed a special labyrinth construction that shuts out debris from infiltrating the outboard rollers.

Sufficient rotation performance is maintained since there is no contact between extended pins and outboard rollers. On the other hand, since the gaps overlap mechanically in layers like a labyrinth, it is more difficult for debris to penetrate into the interior of the rollers.

This special construction solves the problem of debris causing premature wear.

In addition, the embedded bearings enable rollers to rotate smoothly, which can greatly reduce equipment load, reduce operating costs and extended replacement intervals.

Labyrinth Construction

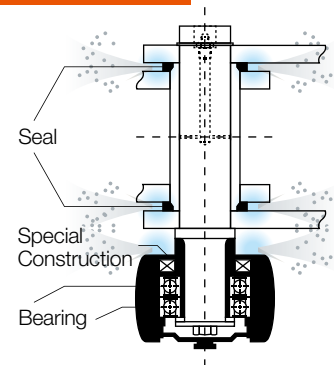

FB Series Large Size Conveyor Chain

Tsubaki FB Series large size conveyor chain has a unique mechanism to prevent chain elongation. It features a solid lubricant that is bonded between pins and bushes, and a special seal between outer and inner link plates, to prevent conveyed material from entering the bearing areas of the chain. At the same time, the mechanism prevents the solid lubricant from escaping. Thanks to this design, FB Series minimizes wear between pins and bushes for a longer wear life than standard Tsubaki chain.

Enlarged diagram of bearing area

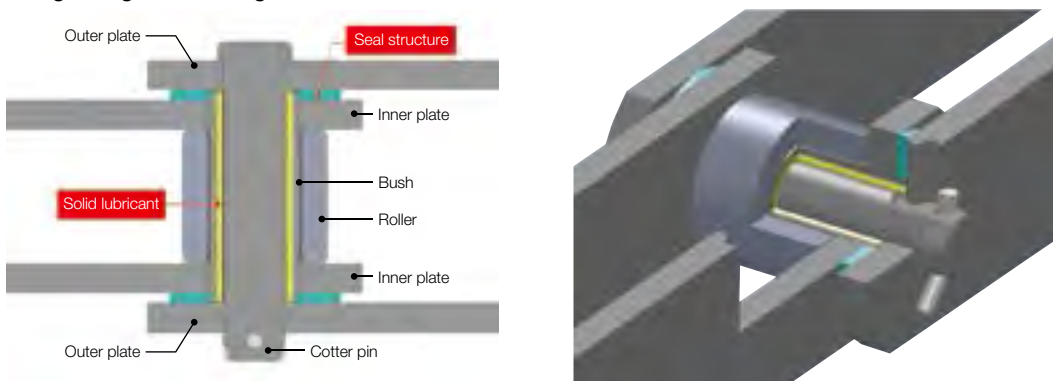



Coal Handling Preparation Plants (CHPP)

Coal Handling Preparation Plants (CHPP) are large facilities used to remove (wash) the grime and sediment (soil, rock, etc) from coal in order to prepare it to be transported to market. The cleaner the coal is, the higher the market value will be, plus less waste material means less weight, resulting in lower overall transportation costs.

Widely utilized within CHPPs is Tsubaki's full lineup of RS Roller Chain G8 and lube-free Lambda Chains. As conditions can make chain lubrication difficult, these chains allow for long wear life without additional lubrication, keeping your CHPP running longer, cleaner, and reduce the impact on the environment.

RS Roller Chain G8



One hundred years of fundamental technology, and the endless pursuit of new value.

Tsubakimoto Chain has worked tirelessly on improving chain performance since our founding in 1917. We were the first Japanese factory to be accredited by Japan Industrial Standards (JIS) for roller chain in 1953. We dubbed that roller chain our first generation chain, and every decade since we have made major leaps in performance up to the 2006 launch of our G7 Series, the world's highest quality roller chain. To celebrate our 100th anniversary, we launched our next generation G8 Series, the next evolution of our chain line.

LG Solid Bush Patented

Tsubaki proprietary LG (lube groove) technology has been applied to the inside surface of our cold-forged seamless bushes. The combined effect of "seamless + LG" effectively doubles the wear life over previous bushes.

(Applicable sizes: RS90 to RS140)

*LG (lube groove) Technology (patented): Tsubaki proprietary technology that includes lubrication in the grooves on the inside surface of the bush to retain the beneficial effects of lubrication longer.

Note: The wear life and kW ratings of sizes RS60 and smaller have not changed.

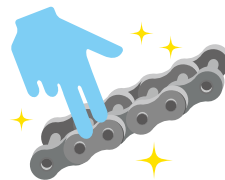

Reduced tackiness thanks to an anti-rust pre-lube specially developed by Tsubaki

20% longer wear life (compared to G7 Series)

(In-house test comparison)

Evolution of chain wear life

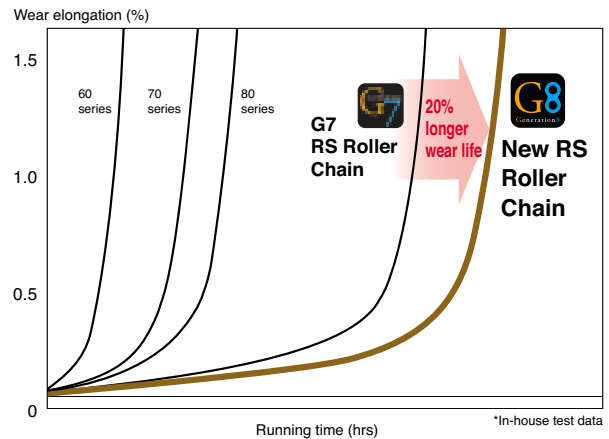

Tsubaki Roller Chain History

1995 Ring coined connected links

2006 Lube groove solid bushes

2009 G7-EX Expanded G7 line-up

2016 Launch of Tsubaki's 100th Anniversary model

80series 25% better kW ratings, 30% better wear life

70Series 2x better wear life, zero initial elongation

1995 33% better kW ratings, 2x better wear life

1985

1976 60 Series 7% better tensile strength, 25% better kW ratings, world's top quality

1969 53 Series 15% better tensile strength, global quality

1964 NA Series 100% better kW ratings

1953 612 Series Conforms to JIS standards

1917 Founded

2002 Kyotanabe Plant operations begin

Engineering, Heat treatment, High speed press, Kyotanabe Plant

G8 series LAMBDA® Chains



Tsubaki's Lube Free LAMBDA Chains were the first in the industry to use a special oil-impregnated bush. Since their launch in 1988, they have been adopted for diverse industries and applications, and their performance has been highly rated.

Lube-free and Long-life

Longer lasting chains made possible by special oil-impregnated bushes.

Compatibility

Compatible with RS Roller Chains.
(RS40-RS160, RF06B, RS08B-RS24B)

Operating Temperature

-10°C to 150°C / 14°F to 302°F

Selection

Use the General Selection Method.

Plates

(standard LAMBDA chain):

- ▶ Inner/outer plates are blackned (nickel Plating / NEPTUNE Specification):
- ▶ plating (excluding bushes)

*The inner link plate is one size thicker to ensure tensile strength; therefore, the pins are longer than with general use roller chain. Ensure there will be no interference with equipment when replacing roller chain with LAMBDA Chain.

Oil impregnated sintered bushes use NSF-H1 certified oil

Basic LAMBDA Chain construction

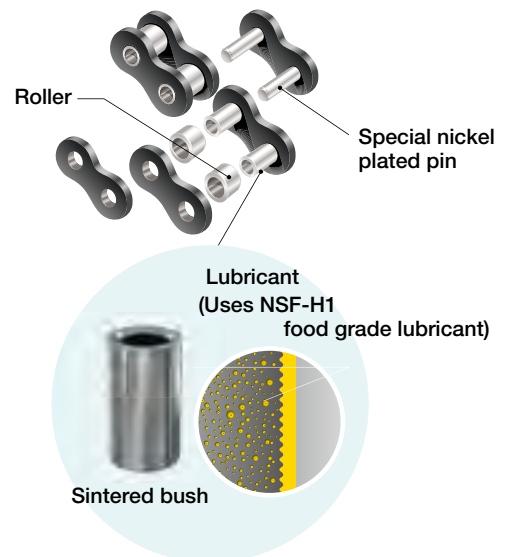

LAMBDA Chain

Products

Tsubaki has a wide line-up of lube-free, long life products that help customers reduce costs, while also reducing their impact on the environment. These include Standard Lambda Chain, Surface Treated LAMBDA Chain (Nickel/NEPTUNE specification) Heavy Duty LAMBDA Chain, Curved LAMBDA Chain, BS LAMBDA Chain, etc. For conveyance needs a wide variety of specialized attachments are also available. Please contact your local Tsubaki representative for more details.

Long life without additional lubrication

G8 Series LAMBDA Chain can offer up to twice the wear life of previous LAMBDA Chain under particular conditions.

*In-house test results; actual results will vary depending on operating conditions.

Titan Chain



1



2



3



4

1. Special Coated Pins

Provide an extra hard, low friction surface limiting the wear between the pin and bushing area, significantly extending wear life, and providing robust performance even in high debris environments.

2. Zinc Coated Pin Link Plates and Black Oxide Roller Link Plates

Tsubaki's patented PerforMax™ bushings are cold formed from a solid piece of steel providing seamless construction. The solid construction and round shape means better surface contact between the pin and bushing while lube grooves on the inner surface of the bushing retain oil at the point of contact, further increasing wear life. The Performax bushing is offered in sizes 80-140.

3. Solid Lube Groove Bushing

Tsubaki's patented PerforMax™ bushings are cold formed from a solid piece of steel providing seamless construction. The solid construction and round shape means better surface contact between the pin and bushing while lube grooves on the inner surface of the bushing retain oil at the point of contact, further increasing wear life. The Performax bushing is offered in sizes 80-140.

4. Ring-Coined Connecting Links

Tsubaki's patented ring-coining process increases fatigue strength and durability of the connecting links. The unique process causes positive compressive stresses around the pitch holes to counteract shock loads. This provides longer service life in your most demanding applications.

Titan Series Chains are available in a variety of options for your drive chain applications, including:

Single and Multi-Strand

Attachment

Made-to-Order

Sizes 35-240



Tandem Drive Road Graders



Mining Shovels (Excavators)



Tandem Drive Road Grader



Spline Bore Drive Sprocket

Graders are used for leveling out roadways and keeping things running smoothly on the mine site. Their operation is vital to keeping the cost down on wheel loaded equipment such as dump trucks and wheel loaders. Tsubaki offers a complete range of Tandem drive chain replacement kits to suit nearly every make and model of grader on the market today, with specific design features to withstand the shock loads and drive forces these systems produce.

Our G8 Series Heavy Duty Roller Chains products will keep your equipment driving. See page 12 for details.

Mining Shovel (Excavator)

Driven by high-class Heavy Duty Drive Chain, mining shovels are used to move earth, load trucks and excavate relatively smaller areas (compared to bucket wheel reclaimers). These highly versatile machines are the modern day workhorses of almost any mining site the world over. Multi Strand Winch Drives of 6 to 8 strand sets are used to drive the cable winch drum, which raises and lowers the shovel head. Cables are connected to the large drum and driven by an electric motor. Our RS Roller Chain (Pg.22) and Tsubaki Heavy Duty Chain (Pg.16) are widely utilized and trusted in these core operations. Let Tsubaki keep your site running, even in the harshest of conditions.



Ideal for Track Drives



RS60-6 Chain

Underground Mining

1 SHUTTLE CAR
Shuttle Car Chain (Pg.30), Sprockets (Pg.42)
ANSI Drive Chain (Pg.22)

2 FACE/ROOF DRILLER
Heavy Duty Drive Chain (Pg.16),
Kabelschlepp Products (Pg.66)

3 CONTINUOUS MINER
Continuous Miner Chain (Pg.34),
Sprockets (Pg.42)

4 BRIDGE CONVEYOR
Sprockets (Pg.42)

5 FEEDER BREAKER
Feeder Breaker Chain (Pg.18), Sprockets (Pg.42)

6 MINE VENTILATION
Cam Clutches (Pg.62)

7 DRIFT/INCLINE CONVEYORS
Back Stops (Pg.62), Power Locks (Pg.38), Power Cylinders (Pg.58)

8 DE-WATER AND SLURRY PUMPS
Back Stops (Pg.62), Power Locks (Pg.38)



When desired material deposits are located at levels too deep or too expensive for surface mining techniques, the job must go underground. The desired material is extracted either via blasting or specially designed machines such as long wall miners and continuous miners. The material is then transported to the surface for further processing via various means including conveyors. Prior to being transported to the surface the material can be handled via shuttle cars and bridge conveyors, and sized via feeder breakers.

In this extreme environment, shock loads are high and chain and/or sprocket failures can take hours to fix. Thus, efficient and reliable extraction can make the difference between profits and losses. You need to get in and out as quickly as possible, which means maximum performance from every piece of equipment on your site.

For these harsh applications, Tsubaki offers their specially designed shuttle car chains, heavy duty chains, and chains for continuous miners.

Shuttle cars are the workhorses of the underground mining system, transferring coal from the development face to the transport conveyors.

Shuttle Car

These machines load and unload hundreds of tons of coal per shift and operate around the clock in the harshest of environments. Critical to the output of the mining operations, operators demand the most of the equipment and components and Tsubaki has been a proven partner for decades and continues to lead the way in product materials and service.



Tsubaki Shuttle Car Chain

SHUTTLE HAWK

Increase Your Shuttle Car's Dependability with Tsubaki's Rugged Shuttle Car Chain

As the world's leading manufacturer of rugged chains designed exclusively for the mining industry, Tsubaki manufactures the traditional 3.075" pitch and the latest and most common 4.100" pitch Shuttle Car Chain for use on new or existing shuttle cars. Tsubaki Shuttle Car Chain will provide two major benefits to your mining operations: Reduced maintenance costs and safer machine service.



Tsubaki Shuttle Hawk 4.100"

Designed for Optimum Wear Life

The two key design features of the Shuttle Car Chain are: all steel construction of specially selected materials and heat treatment for optimum wear life.

This specially designed product provides you with increased values, savings, and performance for your Shuttle Car applications. For more details please contact your local Tsubaki representative.

Available Sizes
2.609"
3.075"
4.100"



Sprocket Assemblies

Tsubaki can supply complete shafts and sprocket take-up assemblies either in complete kits or component format.

We can reverse engineer all components and adopt additional manufacturing upgrades to material properties and sprocket design features at our manufacturing plant in Canada.

LONGER LIFE • LESS DOWNTIME • LEADING SERVICE & SUPPORT

INNOVATIVE SOLUTIONS FOR DEMANDING APPLICATIONS



IRON HAWK®



U.S. Tsubaki proudly introduces Iron Hawk to our distinguished mining portfolio. Engineered, forged and made in the U.S.A. to be as resilient and tough as the miner it was developed to serve.

LONGER LIFE • LESS DOWNTIME • LEADING SERVICE & SUPPORT

IRON HAWK®

- Direct drop in replacement for most OEM shuttle car and straight bed equipment.
- Proprietary heat treatment throughout for ultimate performance and extended life.
- Four standard wingspans (22.5"/26.5"/30.5"/36.2"); custom lengths available.
- Full line of mating sprockets available.
- 100% made in the U.S.A.

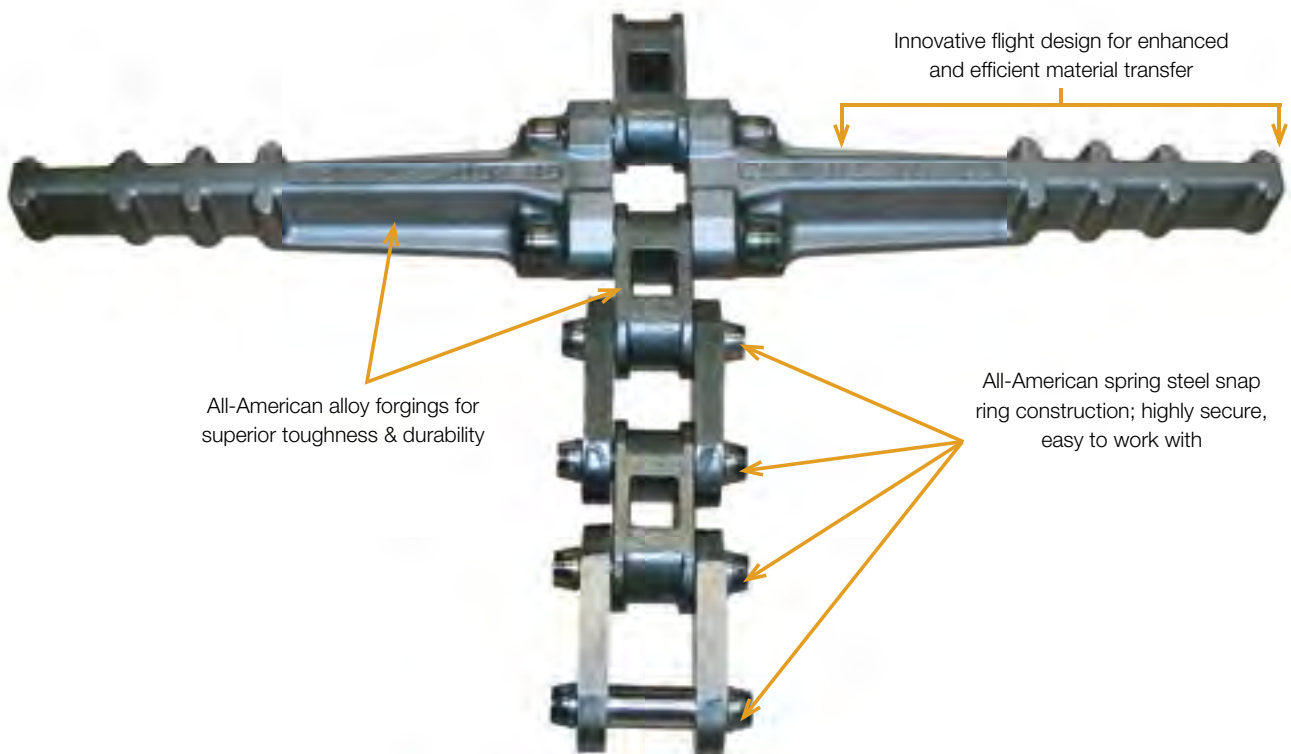

Engineering Chain Plant - Sandusky, OH



STOCKED IN STRAIGHT RUNNING AND SWIVEL TYPE



Face & Roof Drilling



Continuous Miner Product Transfer Systems (Mobile Bridge Conveyor – Jiffy Conveyor)

Face and Roof Drilling

Face and roof drillers are the first machines into newly opened areas to shore up the roof and walls and make it safe, and having Tsubaki as a partner to get this job done makes it all that much easier. Whether you are drilling for the next blast or setting in roof bolts, our products work underground with you.

For this application, Tsubaki chains are specified by major OEMs and replacement parts specialists for performance and reliability, which makes your choice even easier.

With special Heavy Duty Drive Chains (Pg.16) and surface coating (Pgs.18) to prevent corrosion and failure, the Tsubaki chain line up is second to none.

The chains are available in cotter pin specification for easy breaking and assembly in underground operations.

With special Heavy Duty Drive Chains (pg.16), Japanese-made Leaf Chain, and surface treatment combinations to prevent corrosion and failure, the Tsubaki chain line-up is second to none.

Surface coating treatments for chain available upon request:

-NEPTUNE

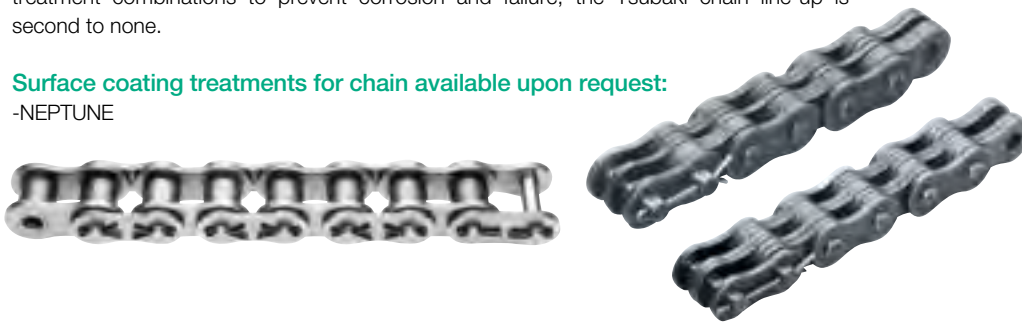

Continuous Miner

Continuous miners are large machines that work directly in the coal face, scraping material from the wall/ceiling with their giant teeth set on rotating steel drums. Being able to mine well over 30 tons of coal per minute, these machines are the heart of modern underground mining.

Tsubaki manufactures tried and tested products at our US facility based in Sandusky, Ohio. For decades, the market has relied on Tsubaki products – used by OEMs, asked for by customers, and demanded when reliability and reduced downtime are your objectives.

Track Pad Sizes: 11" } Chain Pitch Size: 4.760"
 15" }



Although Tsubaki was born and built through innovations in chain technology and development almost 100 years ago, chain is definitely not our only world class product. To facilitate and support our many lines of high class and highly reliable chains, we at Tsubaki have gone the extra mile to independently design and manufacture our own line of top-grade carbon steel, alloy, and stainless steel sprockets for use with our chains in a wide variety of industries, including mining.

Also, as safety on the work site is of the highest priority to Tsubaki, we have developed our revolutionary series of Cam Clutches, Back Stops, and Power Lock devices. Utilized in various applications and industries, the highly refined construction of these unassuming devices provides safety on the job site. Cam Clutches and Back Stops allow freewheeling or overrunning in one direction, and driving or backstopping in the other, protecting both your equipment and employees, while Power Locks eliminate backlash damage to keyways from heavy loads.

Guide It



Lock It



Drive It

Specialty Mining Products

Furthermore, for applications where linear motion is required, such as flop gates, opening and closing of roofs and doors, etc., Tsubaki is proud to provide their full line-up of compact and self-contained power cylinders. Utilized in industries such as mining, power stations, ports, and so on, these extremely sturdy units may even be operated from remote locations, further increasing the safety and efficiency of your site.

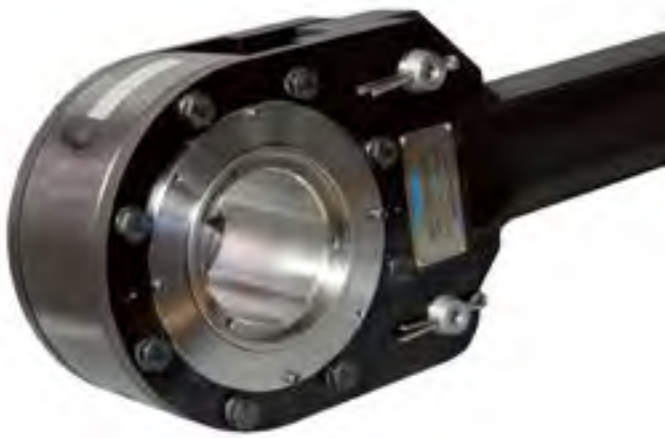

Hold It



Lift It

Specialty Mining Products



Our Power-Lock solves your problems. Eliminate backlash damage to keyways from heavy loads: the Tsubaki Power-Lock fits tightly without backlash around the shaft/hub and is not affected by load reversals. End your high machining expenses for long shaft keyways, splined shafts, threads, grooves and steps. The Tsubaki Power-Lock offers exacting, slip free location. Erase the headaches of shrink and press fits. The Tsubaki Power-Lock simplifies installation and removal.

Power-Lock[®]

AS-Series & AD-N-Series

This easy-to-install unit slides into position and offers a keyless, shaft-hub lock that will simultaneously handle both high torque and thrust while increasing your shaft strength. The Power-Lock is easy to assemble, with only one tool needed. It is ideal for locking in large or small sprockets, conveyor pulleys, gears and rollers.

Power-Lock®

Features & Applications

High Durability Against Reversing or Impacting Loads

The Power-Lock connection is not affected by torsional load reversal or impact which damages the key and keyway connection. Tsubaki's Power-Lock fits tightly around the shaft/hub and is free of backlash.

Easy and Precise Positioning

The Power-Lock offers 360 degree angular adjustment and is excellent for Indexing Tables, Cam Mechanisms, Gear Drives and Double Strand Conveyor Sprockets, Head Shaft Pulleys, Torque arm levers for power cylinders, large drive sprockets and gearing.

Thrust Capability

The Tsubaki Power-Lock can hold axial forces too. Typical applications with these forces include indexing tables, bevel gears, conveyor pulley drums, reclaiming drive sprockets, feeder breaker drive shafts and drive gearing.

Easy Assembly and Disassembly

The Power-Lock can be assembled and disassembled frequently, so maintenance or replacement of worn parts is simple and easy as compared to other methods (key and keyway, spline, shrink or press fits, and welding).

Increased Shaft Strength

By using the Power-Lock, no metal needs to be removed from the shaft (such as the cutting of a keyway). The strength of the shaft can be kept at its original diameter. The effects are especially seen on hollow-shaft applications.

Eliminates Costly Machining

There is no need for time-consuming machining of keyways. The Power-Lock offers substantial savings on long, heavy shafts.



Construction

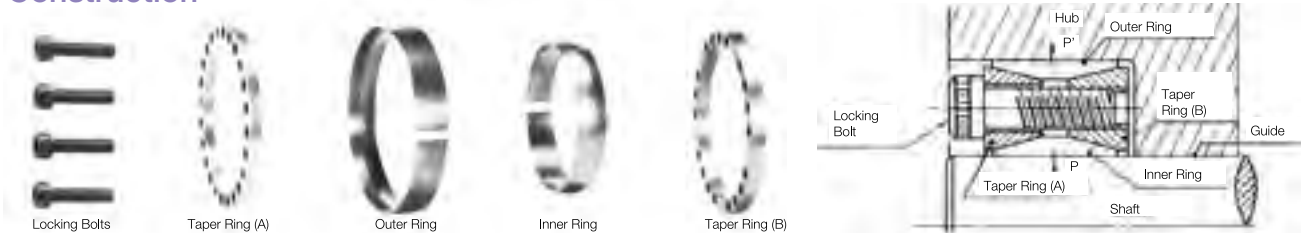

Taper rings (A) and (B) fit perfectly with the tapered inner and outer rings. By tightening the locking bolts, taper rings (A) and (B) generate clamping pressures (P' and P) against the outer and inner rings to produce the frictional force to join the shaft and hub. A slit is provided on the circumference of the outer and inner rings to prevent reduction of the clamping force.

AS Series (Available in metric and imperial sizes)



1. Can be assembled and disassembled any number of times.
There is no relative movement, and therefore no points where wear will occur, making maintenance simple.
2. Available in metric and inch sizes.
3. Available in stainless steel type.
4. Available in zinc plated bolt type.

Applicable Shaft Size: 19 to 500mm

AD-N Series



1. Same inner and outer diameters as the AS-Series.
2. Large capacity locking device that has approximately twice the locking power of the AS-Series.
3. Centering Function
The AD-N-Series has excellent coaxiality with the boss during installation.

Applicable Shaft Size: 45 to 300mm



Tsubaki is proud to offer its large line up of highly customizable Large Size Conveyor Chains. As these conveyor chains are highly customizable, with a variety of materials and corrosion resistant coatings, attachments, and roller types available to match the unique conditions of your mining site, we at Tsubaki are confident that our Large Size Conveyor Chains can meet any challenges your site has to offer

Large Size Conveyor Chains

These machines load and unload hundreds of tons of coal per shift and operate around the clock in the harshest of environments. Critical to the output of the mining operations, operators demand the most of the equipment and components, and Tsubaki has been a proven partner for decades and continues to lead the way in product materials and service.

Wide selection of Large Size Conveyor Chains

Tsubaki Conveyor Chain is made from carbon steel, high tensile structural steel, or stainless steel (300 / 400 Series) parts to satisfy any application.

Basic Models

The following series are TSUBAKI's basic models of materials and heat-treatment combination.

DT

General Use

Our most versatile chain

AT

Heavy Duty

Features twice the maximum allowable load of DT Series

GS

Corrosion Resistant

Stainless steel chain with better corrosion resistance than DT Series

SS

Heat/chemical Resistant

Stainless steel chain with superb corrosion, chemical, heat, and cold resistance

Currently, we have added advanced versions of our four basic series. By the 'Advanced Models', now it's easy to make the smart selection.

Advanced Models

These are line-ups with higher functionality than the basic models.

DTA Has 3x the bush – roller wear resistance of DT Series!

Better corrosion resistance Available sizes RF03 – RF36 (with F or R rollers only)

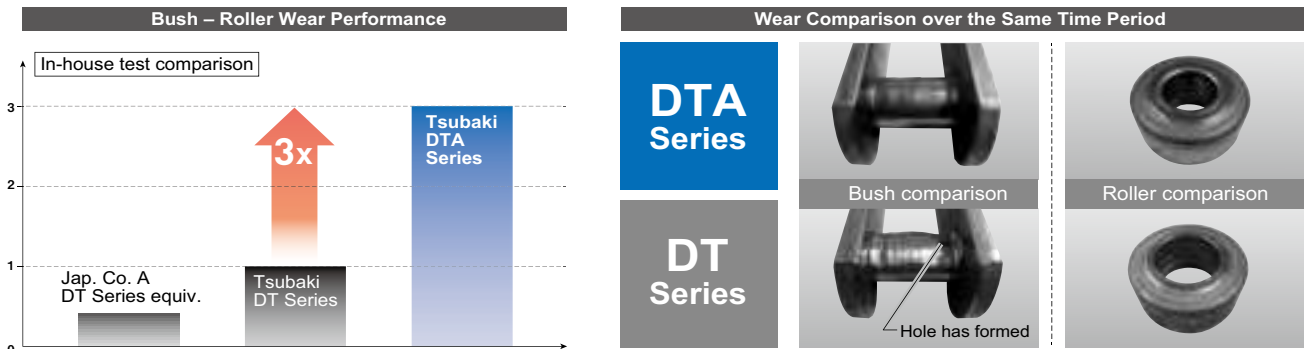

ATA Features better wear resistance and maximum allowable load than AT Series!

Better corrosion resistance and higher max. allowable load Available sizes RF08 – RF36 (with F or R rollers only)

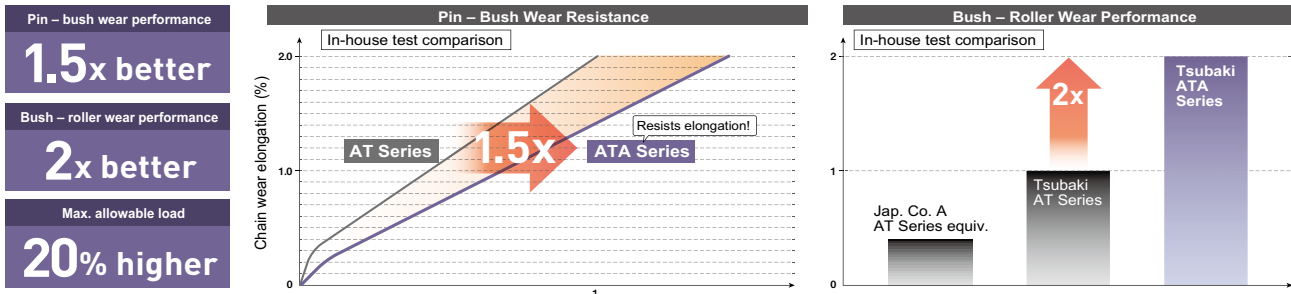

GSA Better wear resistance and higher max. allowable load than GS Series!

Better corrosion resistance and higher max. allowable load Available sizes RF03 – RF26 sizes

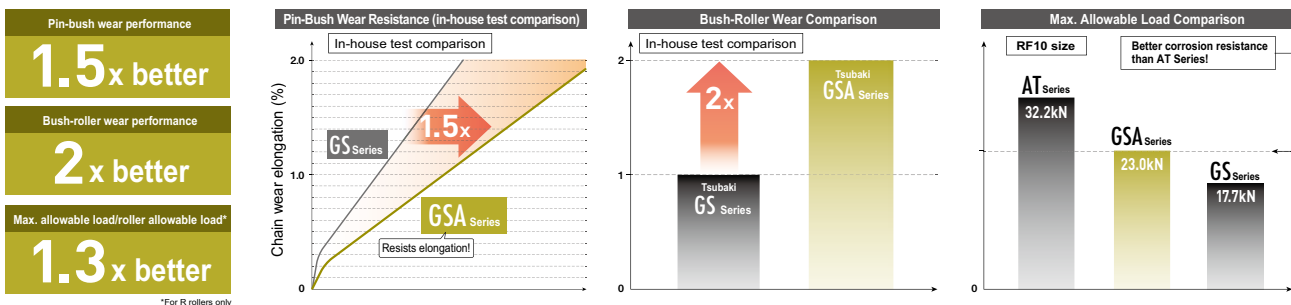

SSA Better wear resistance than SS Series!

Better wear resistance Available sizes RF03 – RF26 sizes





To allow for reliability in the harsh environments of the mining industry, chains and sprockets must consistently work together smoothly, so buying them from the same source makes sense.

Our sprockets are built from top-grade carbon steel to offer long wear life, resist abrasion, and withstand heavy shock loads. Alloy and stainless steel sprockets are also available for extra corrosion resistance and food-grade applications.



Sprockets

You get long service life and reliable performance, turn after turn, time after time, even in the harshest of environments. And it's all part of the Tsubaki Advantage: reliable premium products that don't just perform, they outperform the competition. All the while saving you money.

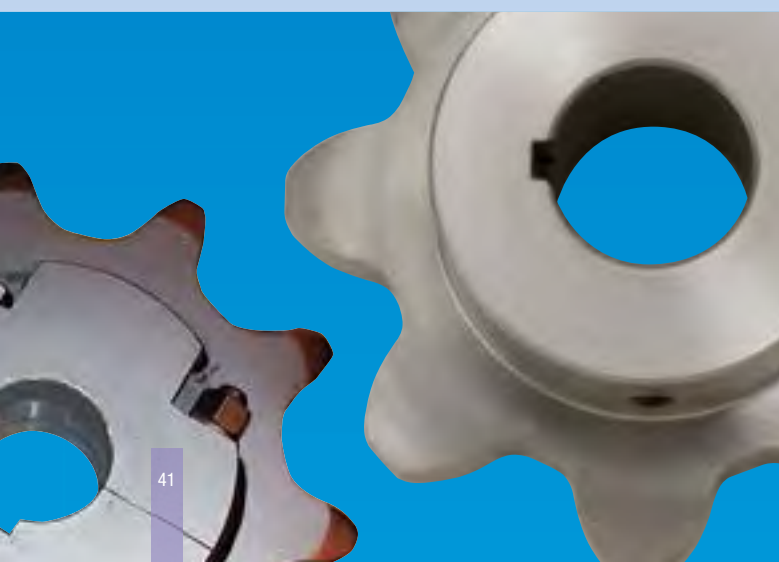

Sprockets

Our Capabilities

- Made-to-order capabilities:
Specializing in high quality Roller Chain and Engineering Class sprockets.
- Short lead times.
- Over 30 years of manufacturing experience.
- ISO 9001:2008 registered.
- Heat treating: Induction, flame, carburizing/case hardening, etc.
*Effective hardness depth maintained in sprockets
- CNC machining for special machined tooth profiles.
- Robotic and submerged arc welding.
- Flame and laser cutting.
- Finishes include paint, powder coat, and black oxide.
Sprockets are stress relieved and balanced when required
Certificates (material/welding) available upon request
- Max Dia. Size: Solid = 2286mm (90")
Segments = 3200mm (126")

Engineering Options

- Split Sprockets
- Segmental Hub & Rims
- Lightening Holes
- Mud Relief
- Installation & operation manuals available.
- Reverse engineering and improvements

Custom Products

- Solid, welded, and custom machined sprockets.
- Mounting, lightening, adjustment, and safety lockout holes.
- Split and Segmental Rim Sprockets
- Mounting methods including straight bores, taper bush styles, drum mountings, splines, Power-Locks and other keyless devices, and much more.

Materials and Coatings

- On request, we can manufacture any sprocket from alloy steel (4140, QT-400) materials.
- Coatings for anti-corrosion and anti-wear are available, including nickel, zinc and others.

Popular Products

- Coal Reclaimer Sprockets
- Drilling Sprockets
- Shuttle Car Sprockets
- Feeder Breaker Sprockets
- Multi-Strand Sprockets



Engineering Class Sprockets



Feeder Sprocket Bore Key



Engineering Class Sprocket
with Flat Teeth



Made-to-Order Split Sprocket

Sprocket Options

Tsubaki can manufacture sprockets to meet your specific needs. The results are sprockets designed to maximize the life of your chain. Chains and sprockets must work together, so buying them from the same source makes sense. When chains and sprockets articulate correctly, the life of the chain is extended. That means long term savings and real value for your application. Tsubaki sprockets can be made in a variety of grades of carbon, stainless, and alloy steels, as well as other metals. Since chain loadings are distributed over all engaged sprocket teeth, tooth breakage or distortion is not normally a problem. It is seldom necessary to use special high strength material. Diameter, pitch, and the number of strands of the sprocket determine the specific grade of carbon steel used. Many of our wide range of carbon steel sprockets are heat treated as a standard. For other sprockets, heat-treating can be specified as an option. Heat-treated carbon steel provides long wear life and resists abrasion.

The hardening process of small diameter, small pitch sprockets is usually a one step procedure using electrical induction heat-treating. Large diameter, large pitch sprockets are usually heat treated using direct flame hardening. These methods are used to provide high hardness at the wear areas of each tooth and maintain a ductile tooth core that is tough and resilient. The hubs and bore remain soft to permit reworking.

Split Construction

Split sprockets allow for easy maintenance of sprockets and machinery because the sprocket can be removed from the shaft without having to disassemble everything around the sprocket. Most Tsubaki sprockets can be supplied as A, B or C Style (hub combinations) split sprockets. Split A Style sprockets (without hubs) can be supplied with bolt holes or mounting brackets to attach to shafts or drums. B and C Styles (with one or two hubs) are supplied with Tsubaki's standard Type I or Type II split hubs, or custom made-to-order hubs.

Split sprockets that cannot be welded are made with oversized hubs to allow for the bolts that hold the sprocket together. Welded split sprockets are manufactured with Tsubaki's standard or custom split hubs.

Segmental Rim

Segmental rim sprockets and traction wheels are split rings (two or more pieces) that generally fasten by bolting to a standard hub body. Segmental rims are usually applied when ease of replacement is desired because the chain, shaft, and bearings do not have to be disturbed during sprocket replacement. When downtime is critical in an operation, consider segmental rim sprockets and traction wheels. Adjustable rim sprockets are also available from Tsubaki. The adjustability of these sprockets allows for precise alignment of multiple sprockets along a shaft. Segmental rims are made of special steel plate material and may be heat treated (optional) to high hardness levels to achieve long service life. Hardened teeth resist abrasive wear common in operation. Consult Tsubaki Technical Support when material being conveyed is cement, ash, or other high hardness material. Special sprocket tooth hardness is necessary to resist wear from abrasive material.

Lightening Holes

Available on request for a wide variety of sprockets. Please contact your local Tsubaki representative for more details.

Mud Relief

In applications where material build up may be a problem, the bottom of the tooth pocket can be beveled on the side to allow the material to "squeeze" out. This reduction of contact area is not critical because the pressure on the bottom of the pocket is very light in horizontal conveyors. Other relief styles may be necessary for vertical conveyors.



Tsubaki's Custom Bore Sprocket



Segmental Rim Sprocket

Adjustable Segmental Rim Sprockets



Quad Sprocket with Lightening Holes

Engineering Class Sprocket Teeth Options

- All Engineering Class sprockets can be provided with “gap tooth” profiles in order to accommodate chain attachments.
- Tsubaki’s standard Engineering Class non-drive style sprockets are manufactured with “Low Profile” teeth. The teeth are not higher than the chain sidebar height to allow for chain attachments. Special flat profile teeth can be designed to clear attachments on long pitch sprockets.
- “High Profile”, or “Long Tooth” sprockets are available on request. The sprocket teeth project out through the top of the chain.



Shipping Methods

- Special shipping methods available, such as custom crates and kits.



- Sprockets are produced by Tsubaki of Canada

STOP THE GUESSWORK

With Tsubaki SMART TOOTH[®]

Sprocket wear is one of the leading causes of premature chain failure.

When you can't waste valuable machine time inspecting sprockets, trust Tsubaki wear indicators to remove the guesswork. SMART TOOTH with patented wear indicator technology to remove the guesswork.

A close-up photograph of a blue sprocket. The sprocket has several teeth, and two of them have small yellow circular wear indicators. The Tsubaki logo, a stylized 'Z' with a lightning bolt, is embossed on the sprocket. Below the logo, the words 'TSUBAKI' and 'SMART TOOTH' are embossed in a bold, sans-serif font. The background is dark, making the blue sprocket stand out.

TSUBAKI
SMART TOOTH

Products to Increase Productivity

Tsubaki Smart Tooth

Drive system inspection and maintenance add cost to any production facility. That's why Tsubaki has created an innovative wear indicator to allow a quick and easy replacement decision to be made.

Too often drive components are replaced at the wrong time: Too early (due to historical practices), costing money and increases downtime, or too late, creating forced shutdowns to replace failed drive systems.

With Tsubaki's integrated wear marks incorporated into the sprocket, the task just got a whole lot easier. So much so that just one glance and you'll know. So Tsubaki has "Stopped the Guesswork," allowing you to save time and money to increase your bottom line and eliminate forced shutdowns from drive sprocket failures.



Sprocket Wear Gauges – Large shaft and multi-tooth segment sprockets

With sprockets used in heavy industries having diameters in excess of three meters and section segment tooth assemblies, they require a tooth gauge that allows several areas to be inspected. Tsubaki again has the solution with a reverse tooth profile available at the time of order. Tsubaki provides a specialized gauge to "Stop the Guesswork" and allow cost savings and planned maintenance to be scheduled in a timely and organized manner.

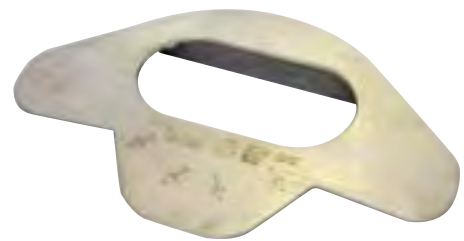

Tsubaki Insert Tooth and Segment Tooth Assemblies

Cost savings are the key to better profitability, and innovative thinking is the way to ensure the very best for our customers. Tsubaki knows the pressures of competition and keeping production moving. Our innovative Insert Tooth Sprockets and Segmental Tooth Assemblies help keep you on track.

- Reduced costs
- Reduced maintenance & replacement time
- Increased production, less downtime
- Increased productivity

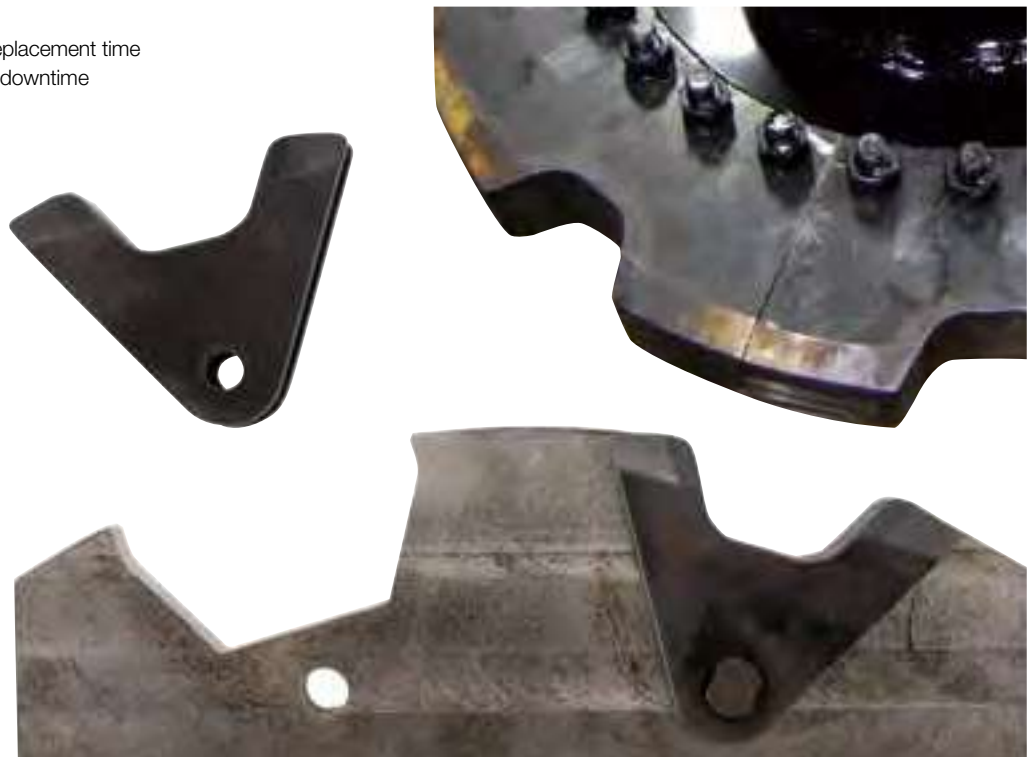

TSUBAKI SMART TOOTH®

WHEN FAILURE IS NOT AN OPTION

Tsubaki SMART TOOTH offers users the ability to identify and schedule drive system maintenance before critical component failure occurs. Strategic placement of our patented Wear Indicator pins on one or more sprocket teeth provides visual indication that a sprocket is still within the allowable wear tolerance, or that it needs to be replaced. When factoring in the cost of critical drive system components, implementation of Tsubaki Wear Indicator technology makes sense for applications that are driven by capital equipment, or where non-scheduled downtime is simply not acceptable.

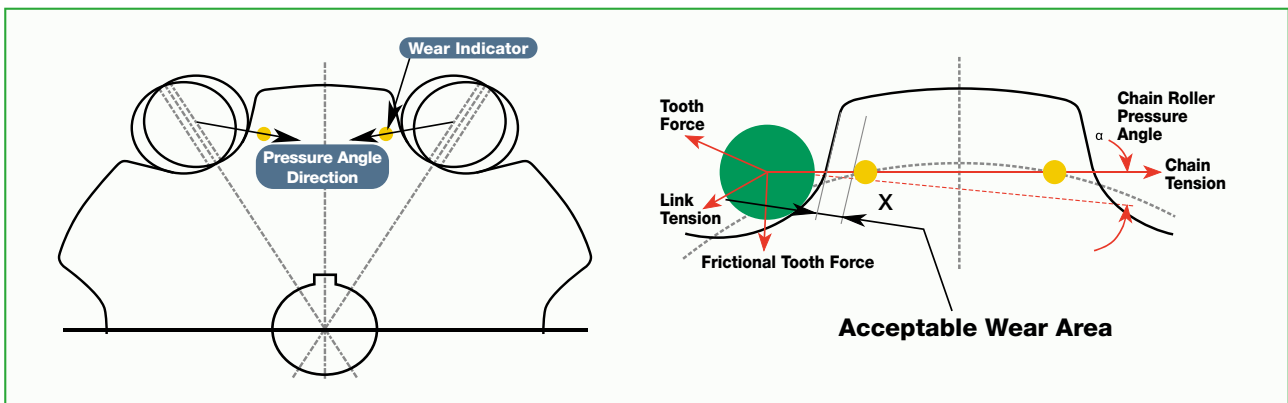

Figure 1 – Theory of Operation

Figure 1 displays how Wear Indicator pins are strategically placed on the thrust faces of the sprocket tooth, where the resultant pressure angle of the chain roller would create wear.



Figure 2 provides a comparison and example of a sprocket that was removed from service due to chain failure. Notice the difference in chain engagement between the new and worn sprocket.

Availability

- ASME 80 through 240 pitch sprockets
- Engineering Class sprockets
- Carbon steel and stainless steel sprockets
- Hardened and non-hardened teeth
- Type A (no hub extension)
Type B (one-sided hub extension)
Type C (two-sided hub extension)
- Taper-Lock. QD and Split - Taper style sprockets

Note: For sprockets that fall outside of these parameters, please contact your local Tsubaki representative

Value

- Extended chain life through predictable maintenance
- Eliminates the guesswork associated with worn sprockets
- Reduces overall cost of equipment ownership
- Provides warning of catastrophic drive failure
- Provides the opportunity to schedule maintenance based on sprocket wear rate

Over time in service, the sprocket tooth profile area is reduced due to induced load created by the chain roller.

The reduction in sprocket tooth profile area creates accelerated wear on the drive chain roller, causing poor fit, alignment, and chain wrap as it relates to the tooth profile. Ultimately, chain wear accelerates at an exponential rate, resulting in loss of tension, jumped chain, drive slipping, and catastrophic failure.

Tsubaki Smart Tooth is your solution!



Patented Smart Tooth sprockets come in a special coating so you know Tsubaki is working hard for you. Just look for the **BLUE!**

Ideal Industries and Applications

Mining:

- Rotary Breakers
- Feeder Breakers
- Reclaimers
- Drill Rigs
- Shuttle Car

Cement:

- Bucket Elevators
- Conveyor Systems
- Rotary Drive Systems

- Reclaimer Systems

Oil and Gas Exploration:

- Coiled Tube Injector
- Draw Works

Other Applications

- Pin Ovens
- Amusement Parks
- Foundries
- Asphalt Plants (Looper Systems)
- Sugar (Cane Conveyors & Sugar Crushers)

TAPER-LOCK® is a registered trademark of Rockwell Automation
QD® is a registered trademark of, and is used under license agreement from Emerson Electric Co

The Tsubaki pin gear drive unit is a new drive unit that replaces gear rack systems.

The combination of a pin-structure wheel/rack and a gear with special tooth profile allows greater freedom when designing rotating or linear drive units.

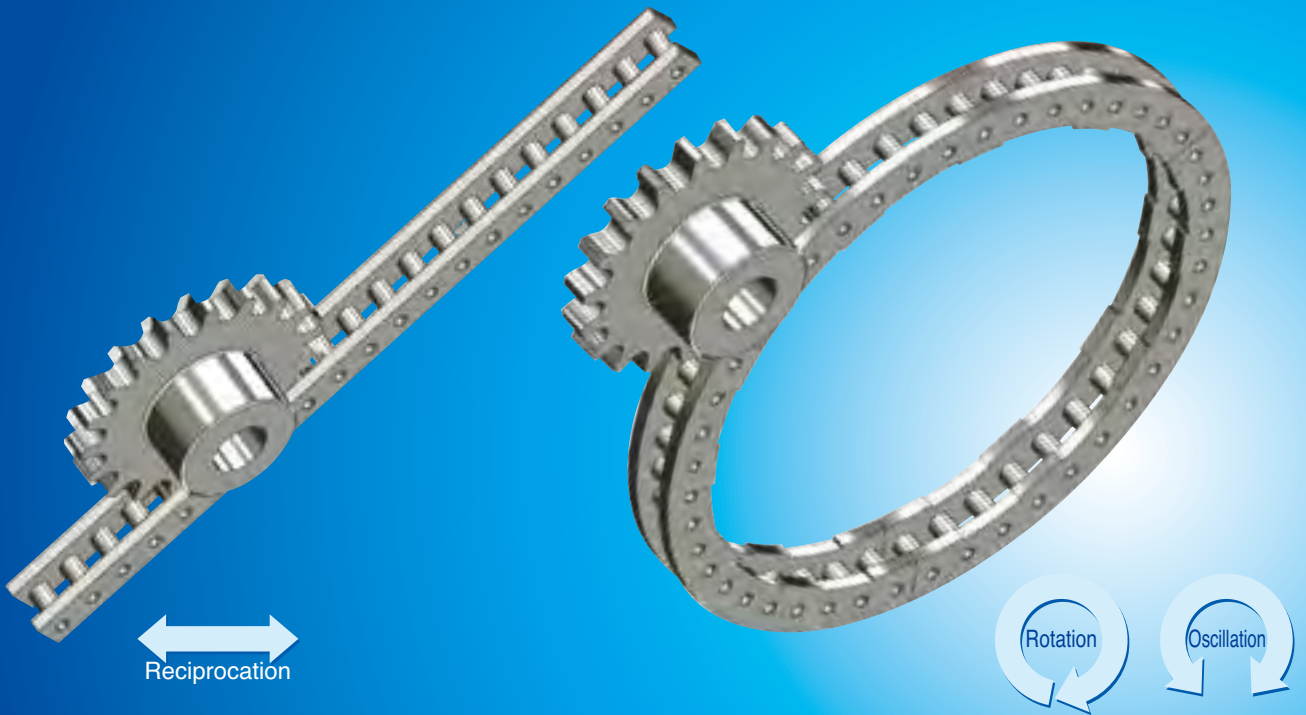

Features

Easy installation

Employs a separable segment design to ensure easy installation.
Can be used even with rough installation precision.

Large transmission torque

Pin gear is designed in forgiving modules and good pin wheel/rack balance delivers large transmission torque.

Can be used in large-scale equipment.

Wheel type units can be employed in large drive units by increasing the number of segments.

Wide applications

Available in steel, stainless steel, and surface-coated models.

Drive system	Installation man-hours	Transmission torque	Large equipment	Cost
Pin gear drive	○	○	○	○
Ordinary gear	△	○	△	×
Chain-type pin gear	△	○	○	◎

Applications

For Rotation



For Reciprocation

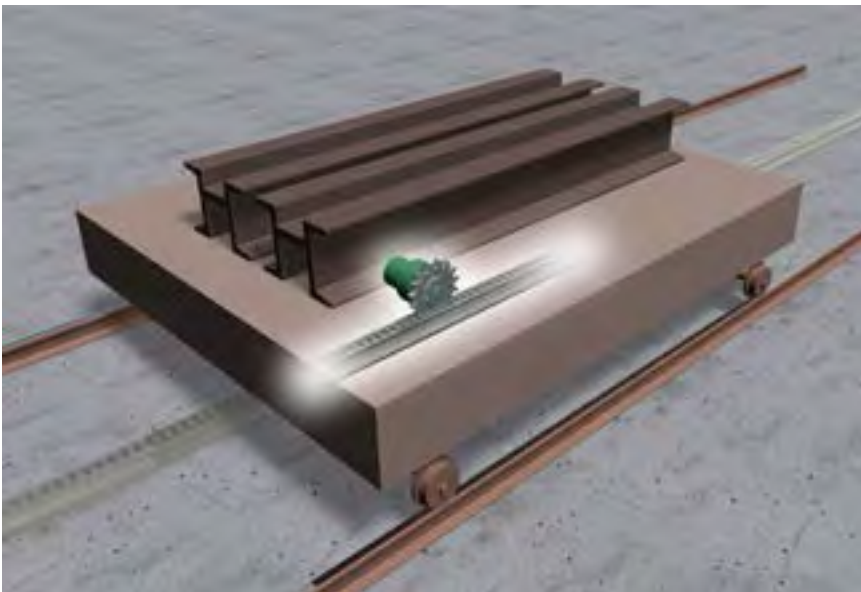

A long, perspective view of a conveyor belt system in an industrial or mining environment. The conveyor belt is supported by a series of green metal rollers and runs along a dirt path. At the end of the conveyor, there is a large, complex metal structure, possibly a hopper or a sorting mechanism. In the middle of the conveyor, there is a tripod-mounted device, likely a sensor or a camera. The background shows a dirt embankment and a blue sky with white clouds.

Cam Clutches Back Stops

Tsubaki Cam Clutch

Mining and conveying go hand in hand, and in a business where transferring product up into CHPP facilities and stockpile reclaim pads is vital, you want to know that you have the right equipment to hold the load to prevent the conveyor from running backward.

Tsubaki brings to the market a mining series of Cam Clutches with a greater torque capacity size-for-size than other clutches, with a full complement of cams on our BS-F series to provide maximum load transmitting members per given diameter. Tsubaki has the most versatile and complete clutch selection there is.

Reliable, tough, field-proven. Tsubaki precision formed cams are “non roll-over-type” with superior durability against shock loads. With cams and races always in contact, you get instantaneous hold reverse.

Whether used on the head shaft pulley, on the geared motor intermediate shafts, or connected to the system via couplings, Tsubaki has the Cam Clutch to get the job done and handle the pressure of your mining site.



Typical Applications

The BS series Cam Clutch was developed for inclined belt conveyors and bucket elevators used in mining and other industries. This specialized Cam Clutch for back stopping applications features superior load resistance and dust protection abilities. One such application in mining for the BR-P Series is on ventilation fans to prevent reverse fan flow when the units are turned off.

Superior Cam Design

With the design of the Tsubaki clutch, you will be running with less energy and heat due to the cam design reducing the effects of friction compared to the roller ramp design. The image on the right shows the roller ramp with a much higher running temperature from its design, which allows centrifugal forces on the rollers to increase the temperature of the clutch. This temperature increase causes premature failure of the oil seals and reduces wear life, which leads to clutch failure.

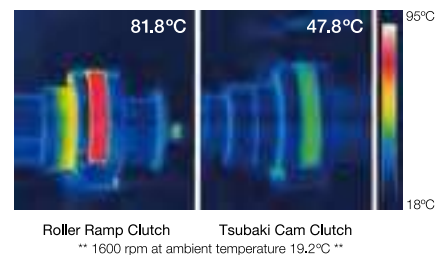

Special Design Features

1. Self Lubrication Function

When the inner race overruns, the rollers also rotate so the cam and roller cage orbit around the inner race outer circumference at a low speed. Grease in the cam and roller cage spreads completely throughout the insides of the Cam Clutch due to this orbital motion, thus maintaining good lubrication.

2. Sliding Speed Diminishing Function

The actual sliding speed of the cams and the inner race is reduced due to the orbital motion of the cam and roller cage, so the wear on the cams is diminished, and a longer overrunning wear life is possible.



Cam Clutches / Back Stops

Tsubaki Cam Clutch - Mining Line Up

BS Series Low speed high torque

A proven field performer for low speed high torque applications. Tsubaki has developed a Cam Clutch that has instantaneous holdback, low noise, easier maintenance, long life and compactness.

This product is ideally situated on the head shaft pulley to prevent any rollback of the conveyor if power failure or system failure occurs.

Typical applications are incline and decline conveyor assemblies.



BS-F High speed, High torque

The next generation in Cam Clutch design that takes the best of all our designs for applications with higher speeds and greater non-rollover than suited to our BS series. Our new design incorporates upgraded Non-rollover cam. Cam & roller cage system contribute smooth lubrication equally from bottom to top.

With a design that often allows for one size down selection compared to our BS series, this unit is a leading edge product. Our design features the narrowest width with I-beam structure. for drop in replacement with the current layout.

Typical applications are the new super conveyor systems with large loads and high speeds.



BR-HT Series Lift off type

This unique product incorporates very special cams to lift off and have no contact with the inner and outer race when in overrunning operations. This is due to centrifugal force, and is the reason why this type of Cam Clutch is known as a *Lift Off Type*.

Suitable for overrunning high-speed inner race/low speed engaged outer race or Backstopping high speed inner race overrunning.

Applications include internal mounting in gearboxes for backstopping. Interchangeable with popular European brands.

Tension release and Torque limiter type is also available.



BR-P Series Lift off type

Same as BR-HT Series but has a body that is wider than the standard BR-HT Series and two deep groove ball bearings to center the inner and outer races, which allow the clutch to be mounted externally on the gearbox intermediate shaft of the conveyor.

Other typical applications are backstopping for emergency pumps on process and inclined pumps.



MG Series

A proven field performer used on the intermediate shaft on small discharge conveyors and transfer conveyor chutes, as well as for backstopping on pumps.

This rugged model comes in either grease or oil filled configurations to suit your needs with a series of different seals and operating conditions.

Typical applications are small discharge conveyors and gearbox backstopping.



BR-HT Series

Tsubaki BR-HT Series Cam Clutches are mainly used in backstop applications with high-speed inner race overrunning. You'll especially find them integrated into gearboxes and in pump applications.

BR-HT assures not only intermediate backstop functions under high torque, but also a long service life thanks to its lift-off design. Installation on high speed shafts with low torque enables selection of more compact, economical models.

Non-contact design

The BR-HT has a special cam with a lift-off design for high speed overrunning operation. The cam has a unique cross-section that provides mechanical engagement only when needed. Otherwise, the Cam Clutch rotates freely with absolutely no mechanical contact in the clutch mechanism. This means greatly increased service life compared to conventional types.

Non-roll over design

Tsubaki BS-HT Series uses the concept of the non-roller over design, one of the most critical elements in a backstop application. The wide, flat contact area of the cam prevents critical cam roll over for safer conveyor operation.

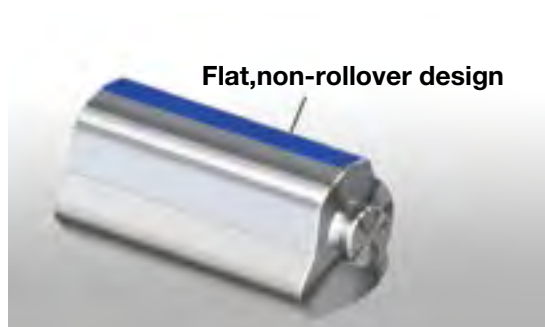

BR-HT Series Torque Limiter type

The torque limiter function releases unbalanced loads or over-tensioned belts on multi-drive belt conveyors.

BR-HT Series Tension Release type

The tension release type works like the torque limiter type but with an additional manual release function. Belt tension can be released during maintenance or overloads and jams.

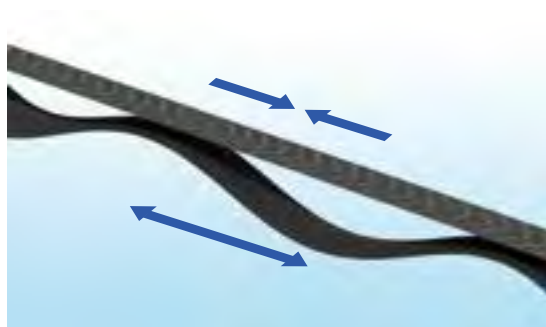
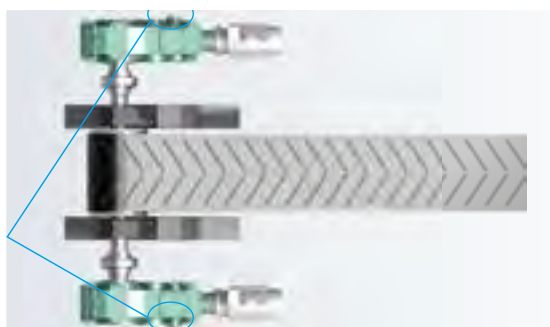

BS-F Series

The new design of the BS-F Series was developed for high speed inclined belt conveyors and bucket elevators used in the mining and bulk handling industries. Tsubaki's design features a narrow width I-beam torque arm that is a drop-in replacement for major competitor backstops.



Non-roll over cam

Tsubaki BS-F Series features an original cam design that achieves higher torques than other major competitors. These cams have a larger profile and wider flat contact area to prevent critical cam roll over and help maintain safer conveyor operation.

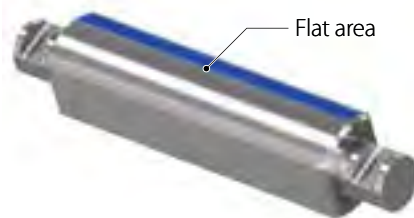
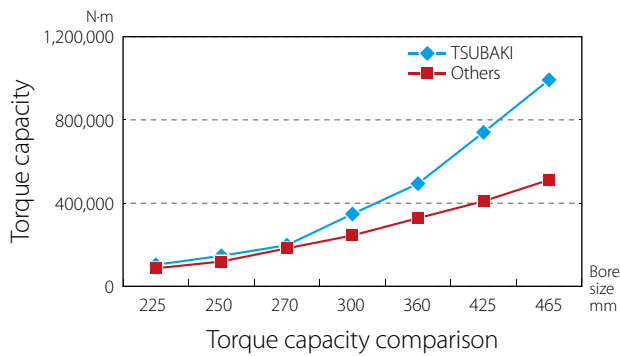

Original cam and roller design for long overrunning life

Our original cam & roller design offers a longer service life. This design continuously circulates grease lubricant from the bottom to the top as the cam cage revolves with roller rotation. This grease is locked in by design, thereby letting users avoid troublesome periodic oil replacement and other such maintenance.



Cam & roller construction

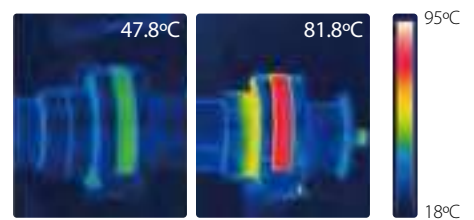

Temperature comparison at the same overrunning speed

Special labyrinth seal

The BS-F Series was developed with a new labyrinth seal design to prevent dust and water ingress in the abrasive conditions typical of mining and bulk handling applications. This seal has a special double lip oil seal with multi-temperature grease for use in a wide range of ambient temperature ranges.

Ambient temperature: -40°C to 65°C, -40°F to 149°F

Sealing performance test by cement powder

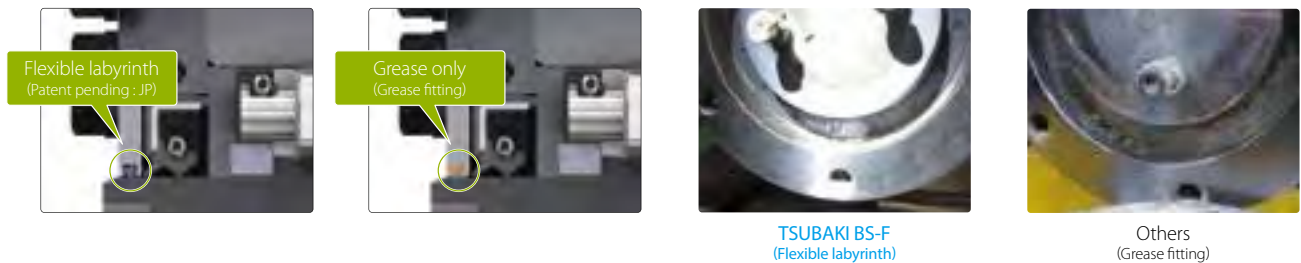

Downsizing

Tsubaki BS-F Series has a narrower width and yet can still meet the needs of high speed inclined belt conveyors. This helps users downsize their operations from competitor products.

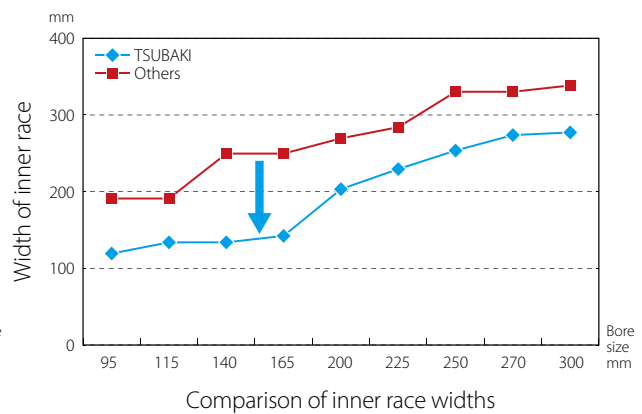
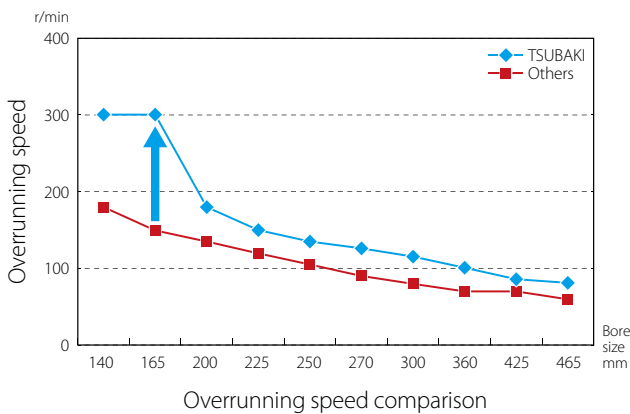

Drop-in design

Tsubaki BS-F Series is the narrowest backstop featuring an I-beam torque arm. This makes replacement on-site quick and easy.

Easy connection in three steps

- Step 1: Insert the I-beam torque arm into the clutch
- Step 2: Insert lock pins through the flange plate and secure the torque arm
- Step 3: Insert retaining pins into the lock pins

Power Cylinders

Tsubaki Power Cylinders are a completely self-contained, motorized linear actuator unit available in a variety of types and speeds. Their compact size and ease of installation make them ideally suited to a variety of mining applications.

These units require little maintenance, and they are mainly used outdoors where there is a requirement for linear motion, such as flop gates, the opening and closing of roofs and doors, coal sampling units and trousers, leg chutes, and clam shells for Reclaimer Tunnels. Tsubaki Power Cylinders consist of an enclosed electric motor fitted with a DC brake rated 150% load capacity, over travel protection and load limiting friction discs. It uses a gear set, ball screw and nut to extend and retract the rod end.

As a standard for tropical applications we can have the unit painted with a rubberized paint and all non load bearing screws and fasteners supplied in stainless steel.

Applications for power cylinders are commonly found in mines, power stations, ports and any application where a self contained linear actuator with no leaky reservoir, hoses, tube fittings, etc. are needed to operate this unit.

As well as being extremely sturdy, the Power Cylinder has either Trunnion or Clevis mounting arrangements, and can be fitted with stroke limit switches, rotary encoders, potentiometers, bellows and other accessories. Tsubaki Power Cylinders lend themselves to convenient operation from remote locations such as other buildings.



Tsubaki Power Cylinder

What Are Power Cylinders?

There are three categories of linear actuators: the hydraulic cylinder, the pneumatic cylinder, and the electro mechanical cylinder which is a power cylinder.

The following is the specs and cost comparison table for these three cylinders.

* One financial unit is equal to 1

	Tsubaki Power Cylinder	Pneumatic Cylinder	Hydraulic Cylinder
Type	LPTB1000HSL	Bore size 200mm	Bore size 50mm
Thrust load	1,000kg	1,000kg	1,000kg
Stroke	300mm	300mm	300mm
Speed	120mm/sec	120mm/sec	120mm/sec
Cylinder cost		0,4	0,1
System cost	1*	2,5	1,5
Electricity expense		18	6
CO ₂ emission		18	6

This is depending on the conditions of operation and the application.

Applications:

- Clam Shell Valves and Knife Valves
- Flop Gates – Trouser Chutes
- Belt Cleaning Scrapers
- Conveyor Material Deflector
- Coal Sampling Units

Power Cylinder G/T/U Series

Thrust force: 0.7kN { 70kgf } ~ 490kN { 50000kgf }

This is a large thrust type Power Cylinder which can be used with an AC power source. The Power Cylinder can be used across a wide range of applications such as mining, steel, cement, injection molding machines, liquid crystal and semiconductor devices. Power Cylinder can be used outdoors. (IP55) (Higher ratings available upon request.)

Two Easy-to-Select Types

Power cylinder has two different types of safety mechanisms. The B type incorporates a slipping clutch and electric Shock Relay. The C type is equipped with a thrust detection limit switch, for press stopping.

Wide Variation

A wide range of standard models is available according to applications, thrust and speed. Thrust force can be selected from a range of 0.7kN { 70kgf } to 490kN { 50000kgf } and speed can be selected in a range from 10mm/sec to 120mm/sec.

Reliable Operation

All models adopt a highly efficient ball screw, silent gear, and highly reliable brake motor. All series incorporate a highly reliable safety device which is effective against overload.

Abundance of Options

The stroke adjusting limit switch includes an external and built-in type, and the stroke sensor includes a potentiometer, a rotary encoder, or both.

Endrod Damper

This is an optional unit designed to take vibration away from cylinders.

Power Cylinders

High Performance Linear Actuators
Offering Efficient, Clean, Quiet Drive

Easy and Economical to Combine with Your Equipment

The mechanical type motor driven actuator reduces the need for compressors, piping valves or hydraulic units, making the equipment simpler and more economical. The device can be treated as a motor and allows for simple remote control. Furthermore, the simple construction and long life grease provide for more economical maintenance.

Ready for Outdoor Use (IP55, higher ratings available upon request)

T Series, G Series, Ultra Heavy Duty Series, F Series, Battery Series

With Electromagnetic Brake Motor

T Series, G Series, Ultra Heavy Duty Series

Multi Type Actuator

Available for synchronized operation with the single motor Multi Series.



Jack Type

(Ball screw or trapezoidal screw)
Lini-power jack available in separate catalog
1.96-980KN
(0.2-100tf)



Internal Position Sensor; Limit Switch Type

Optionally available for signaling the position of the stroke.

Potentiometer (Analog) or Rotary Encoder (Digital)

Optionally available for remote control operation.

Mounting

Trunnion Mount

Clevis Mount

(not available with K2-K4-P-R)

Rod Anti-Rotation Device

Available as made-to-order. If the actuator rod end is free or connected to wire rope, an anti-rotation device for the rod is needed.

Three Phase Motor with Brake

For precise positioning and rigid load holding.

IEC Motor Mounting

IEC flange adaptors available to suit servo motors and customer specific motor units.

Mounting Type and End Fitting

Clevis or trunnion mount and I type end fitting are available.

Bellows

To be used in dusty areas when needed.

External Limit Switches

Optionally available for adjusting the stroke of the actuator.

Press Loaded Stopping Device

For safety and thrust sensing. A combination of disk springs and limit switches is used to provide thrust sensing and press loaded stopping.





— Power Generation —

Power Stations & Port Terminals

— Loading —



Power Stations and Port Terminals

– the two industries commonly use several pieces of equipment:

- Train unloaders
- Stock pile overhead conveyors
- Coal silos, clam shells, and flop gate valves
- Conveyors and transfer towers
- Coal reclaimer chains – Scraper blades and bucket wheels

In addition to these applications, Tsubaki offers products to suit boiler feeder chains and sprockets, Fly Ash Chains, Water Screen Chains for both rotary and traveling screen systems, and Boiler Pumps and FD Fans with our clutch box range.

Port Terminals are the dispatch centers for raw minerals to market. These operations demand high performance products to ensure every ship is loaded on time, every time.

Tsubaki products have a proven track record in this application, operating in many ports world-wide maintenance free for 20 to 25 years, guaranteeing on-time export departures.

Tsubaki Power Cylinders, Cam Clutches, and Chain are the hidden components critical to system operations.

Applications:

- Conveyor gearbox internal holdbacks (BR-HT Series)
- Flop gates, clam shell valves, loading spoon feeders (Power Cylinders)
- Head drums (Power Lock locking elements)
- Tripper car travel chains (Roller Chain)
- Port loading radial boom electrical cable control (Kabelschlepp products)



Power Stations & Port Terminals

— Unloading —

Power Stations and Port Terminals

- Unloading

Unloader Chain

Tsubaki Unloader chain uses unique Tsubaki technology to give it outstanding endurance and a proven track record. We also offer special specifications to meet customer conveyor needs.



Unloader Sprockets

Tsubaki Unloader Sprockets are optimized for use with Tsubaki Unloader Chains. We specially harden them for extremely effective wear resistance.



Steel Cable Carriers

Steel Cable Carriers have excellent strength and heat resistance. Stainless steel and side mount specifications are also available. We also offer an extensive line-up of covered cable carriers for added cable/hose protection.



Side Mount Specifications

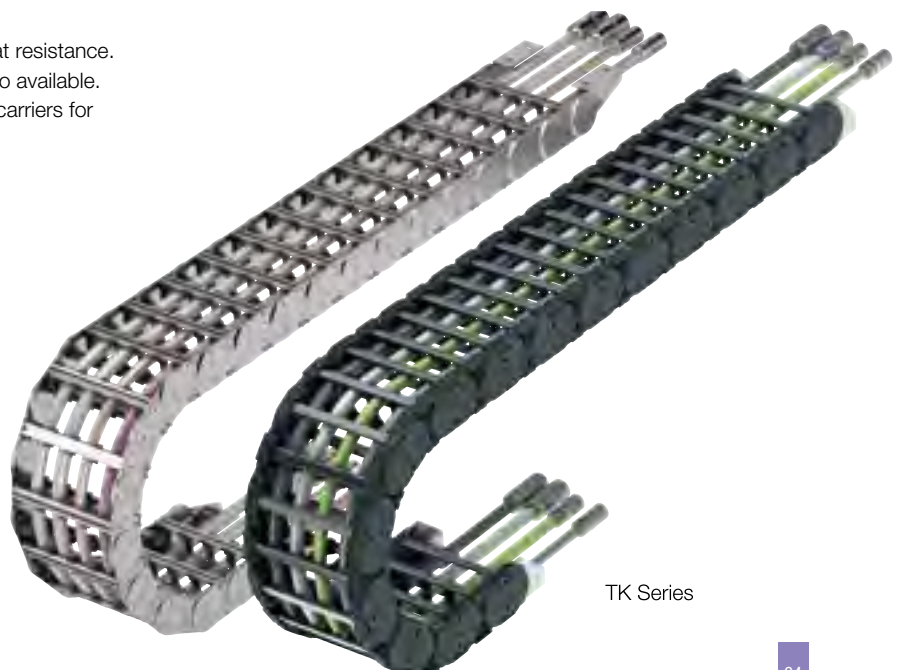

TK Series



Bucket Wheel Bridge Reclaimer



Radial Rotation Cable Support

S & SX Series :
Extremely robust and stable steel cable carriers

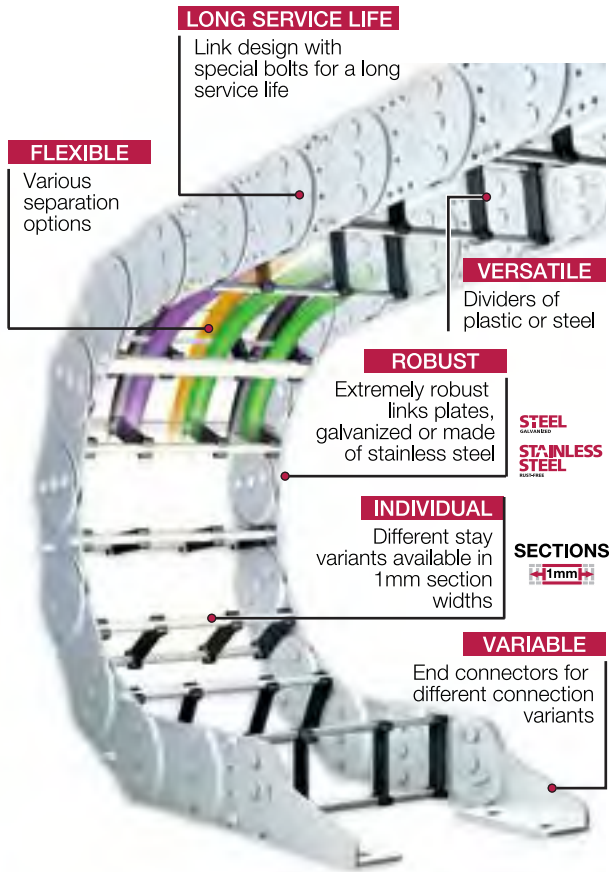

Example of cross section

Cables are neatly positioned, applying less stress and pressure to the external cable insulation and internal cable construction.



Covered versions

Aluminum cover systems ensure extreme cable protection for a long service life even under extreme and harsh environmental conditions.

TKHD series :
Heavy duty cable carriers for long travel lengths

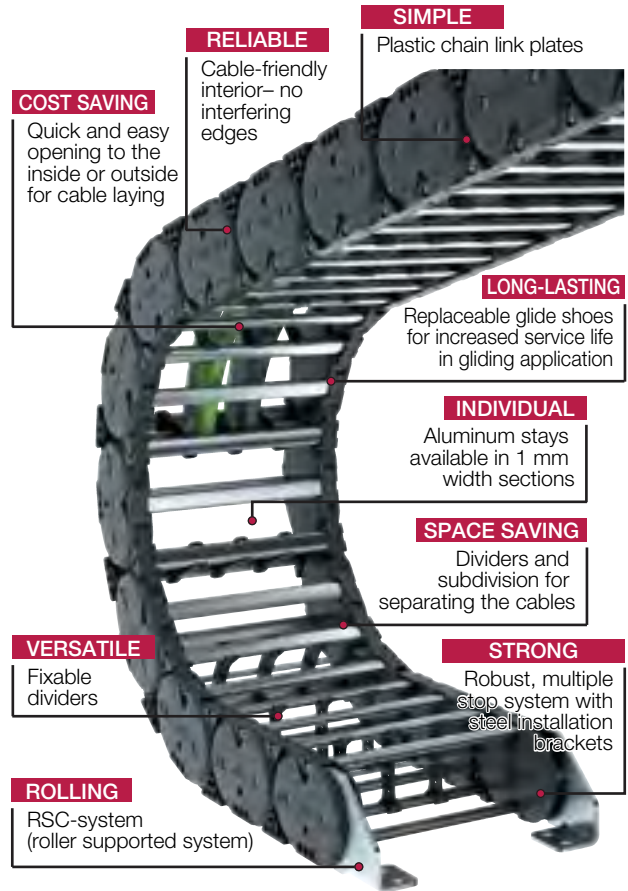

Replaceable glide

shoes for increased service life.



RSC-system

(roller supported system) for long travel length.

Bucket Wheel Stackers/Reclaimers and Bridge Type Bucket Wheel Reclaimers are the machines that feed the mining system. Whether delivering product to the processing plant or transferring product to the rail or seaport for transportation, these machines are the workhorses of the mine site. They operate under the harshest of conditions under the highest of loads, and the individual parts that make up the machine have the highest demands placed on them.

It's here that Tsubaki Kabelschlepp cable carrier systems thrive. Our cable carrier systems are built with the highest degree of engineering and technical know-how in our German manufacturing plant. For stackers and reclaimers worldwide, the product of

choice is the Kabelschlepp Steel Cable Carrier.

The various power and fluid cables used in these machines provide the lifeblood to operate them. If they fail, you're on downtime while your maintenance and production costs start climbing. The Kabelschlepp product is a proven performer with multiple features designed to operate in this environment and protect your cables, such as special protective coatings, versatile dividers, long life bolts, and variable heights and widths to suit a range of applications.

Don't let size worry you; our products range from a single power cable up to units the size of a dump truck.



TSUBAKIMOTO CHAIN CO.

Japan

Headquarters
+81 6-6441-0011
<http://tsubakimoto.com>

Global Group Companies

AMERICAS

United States of America
U.S. Tsubaki Power Transmission, LLC
+1 847-459-9500
<http://www.ustsubaki.com/>

Brazil
Tsubaki Brasil Equipamentos Industriais Ltda.
+55 11-3253-5656
<http://tsubaki.ind.br/>

Canada
Tsubaki of Canada Limited
+1 905-676-0400
<http://tsubaki.ca/>

EUROPE

Netherlands
Tsubakimoto Europe B.V.
+31 78-6204000
<http://tsubaki.eu/>

France
Kabelschlepp France S.A.R.L.
+33 1-34846365
<http://kabelschlepp.fr/>

Germany
Tsubaki Deutschland GmbH
+49 89-2000-133-80
<http://tsubaki.de/>

Tsubaki Kabelschlepp GmbH
+49 2762-4003-0
<http://tsubaki-kabelschlepp.com/>

Italy
Kabelschlepp Italia S.R.L.
+39 0331-350962
<http://kabelschlepp.it/>

Russia
OOO Tsubaki Kabelschlepp
+7 499-4180212
<http://kabelschlepp.ru/>

Spain
Tsubaki Ibérica Power Transmission S.L.
+34 911-873450
<http://tsubaki.es/>

United Kingdom
Tsubakimoto U.K. Ltd.
+44 1623-688-700
<http://tsubaki.eu/>

INDIAN OCEAN RIM

Singapore
Tsubakimoto Singapore Pte. Ltd.
+65 6861-0422/3/4
<http://tsubaki.sg/>

Australia
Tsubaki Australia Pty. Limited
+61 2-9704-2500
<http://tsubaki.com.au/>

India
Tsubaki India Power Transmission Private Limited
+91 44-7101-2000
<http://tsubaki.in/>

Indonesia
PT. Tsubaki Indonesia Trading
+62 21-89458898
<http://tsubakimoto.co.id/>

Malaysia
Tsubaki Power Transmission (Malaysia) Sdn. Bhd.
+60 3-8966-2020
<http://tsubaki.my/>

New Zealand
Tsubaki Australia Pty. Limited - New Zealand Branch
+64 9-352-2085
<http://tsubaki.com.au/>

Philippines
Tsubakimoto Philippines Corporation
+63 2-808-0067
<http://tsubaki.ph/>

Thailand
Tsubakimoto (Thailand) Co., Ltd.
+66 2-262-0667/8/9
<http://tsubaki.co.th/>

Vietnam
Tsubakimoto Vietnam Co., Ltd.
+84 24-6274-1449
<http://tsubaki.net.vn/>

EAST ASIA

Korea
Tsubakimoto Korea Co., Ltd.
+82 2-2183-0311
<http://tsubakimoto-tck.co.kr/>

Taiwan
Taiwan Tsubakimoto Co.
+886 3-3293827
<http://tsubakimoto.com.tw/>

CHINA

China
Tsubakimoto Chain (Shanghai) Co., Ltd.
+86 21-53966651/2
<http://tsubaki-sh.cn/>
