

Adapter Type Outline Dimensions

0.1kW · L : Foot mount type

GEAR MOTOR TA Series

A-11 0.1kW GRTAO10-18L5FI

Reduction ratio : 5 Approx. weight : 6.2kg
Reference page : Specification Chart→P83

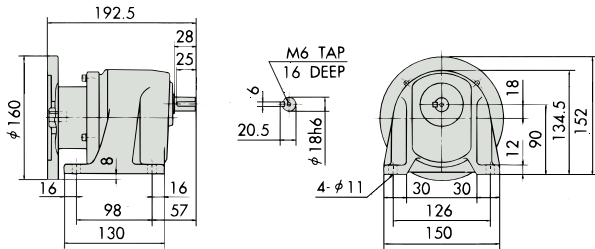

A-14 0.1kW GRTAO10-28L300~450FI

Reduction ratio : 300, 360, 450 Approx. weight : 9.6kg
Reference page : Specification Chart→P83

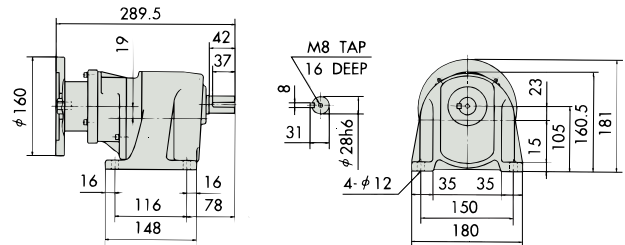

A-12 0.1kW GRTAO10-18L10~50FI

Reduction ratio : 10, 15, 20, 25, 30, 40, 50 Approx. weight : 4.8kg
Reference page : Specification Chart→P83

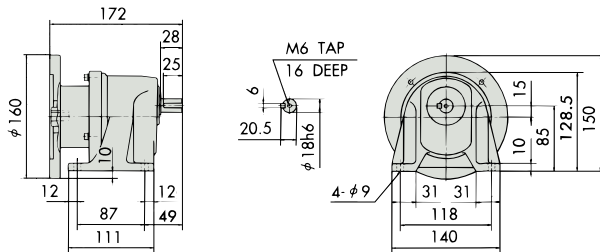

A-15 0.1kW GRTAO10-38L600~1200FI

Reduction ratio : 600, 720, 1000, 1200 Approx. weight : 14.0kg
Reference page : Specification Chart→P83

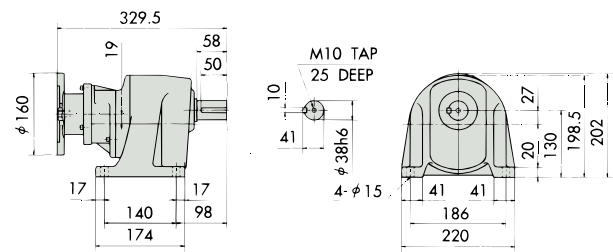

A-13 0.1kW GRTAO10-24L60~200FI

Reduction ratio : 60, 75, 100, 120, 165, 200 Approx. weight : 6.2kg
Reference page : Specification Chart→P83

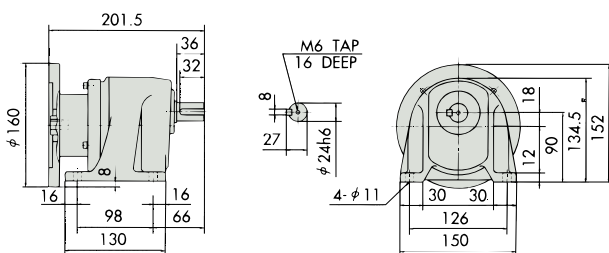

Outline Dimensions

L

A-11
A-12
A-13
A-14
A-15

0.1

Adapter Type Outline Dimensions

0.1kW · U : Face mount type

GEAR MOTOR TA Series

A-16 0.1kW GRTA010-18U5FI

Reduction ratio : 5	Approx. weight : 6.0kg
Reference page : Specification Chart→P83 Options→P57	

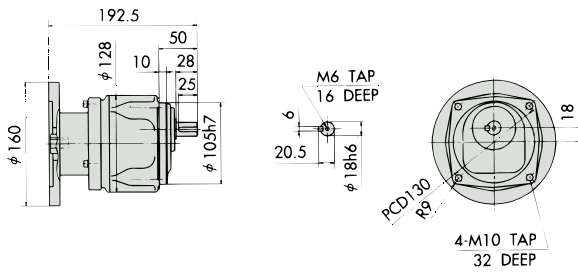

A-19 0.1kW GRTA010-28U300~450FI

Reduction ratio : 300, 360, 450	Approx. weight : 9.6kg
Reference page : Specification Chart→P83 Options→P57	

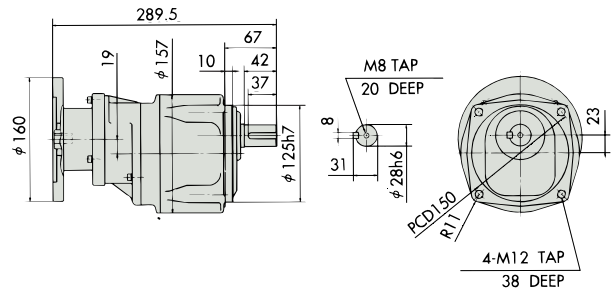

A-17 0.1kW GRTA010-18U10~50FI

Reduction ratio : 10, 15, 20, 25, 30, 40, 50	Approx. weight : 4.6kg
Reference page : Specification Chart→P83 Options→P57	

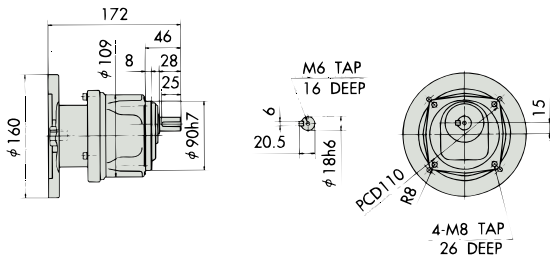

A-20 0.1kW GRTA010-38U600~1200FI

Reduction ratio : 600, 720, 1000, 1200	Approx. weight : 19.5kg
Reference page : Specification Chart→P83 Options→P58	

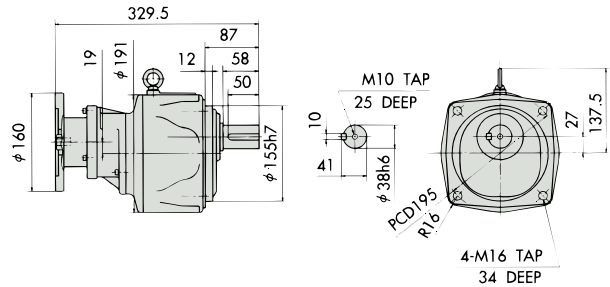

A-18 0.1kW GRTA010-24U60~200FI

Reduction ratio : 60, 75, 100, 120, 165, 200	Approx. weight : 6.2kg
Reference page : Specification Chart→P83 Options→P57	

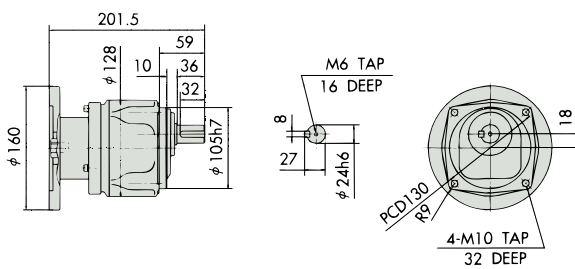

Adapter Type Outline Dimensions

0.2kW · L : Foot mount type

GEAR MOTOR TA Series

A-21 0.2kW GRTA020-18L5FI

Reduction ratio : 5 Approx. weight : 6.2kg
Reference page : Specification Chart→P83

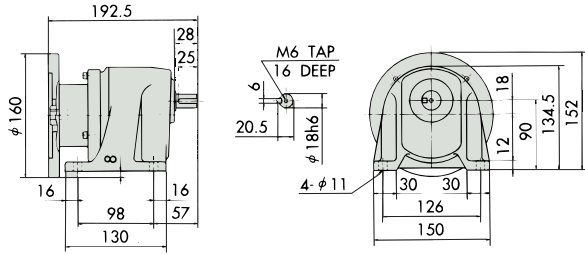

A-24 0.2kW GRTA020-28L100~200FI

Reduction ratio : 100, 120, 165, 200 Approx. weight : 8.6kg
Reference page : Specification Chart→P83

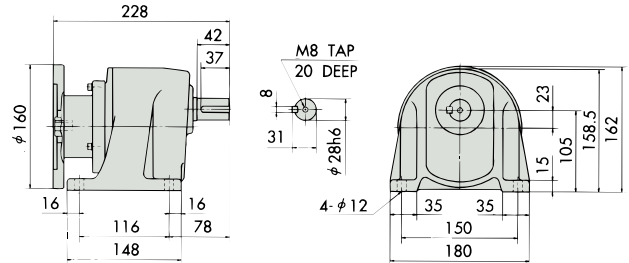

A-22 0.2kW GRTA020-18L10~25FI

Reduction ratio : 10, 15, 20, 25 Approx. weight : 4.8kg
Reference page : Specification Chart→P83

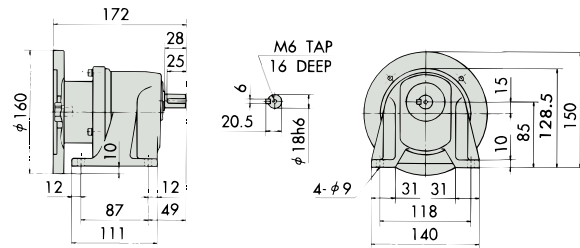

A-25 0.2kW GRTA020-38L300~450FI

Reduction ratio : 300, 360, 450 Approx. weight : 14.5kg
Reference page : Specification Chart→P83

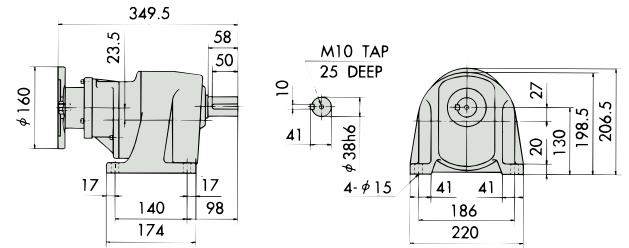

A-23 0.2kW GRTA020-24L30~75FI

Reduction ratio : 30, 40, 50, 60, 75 Approx. weight : 6.2kg
Reference page : Specification Chart→P83

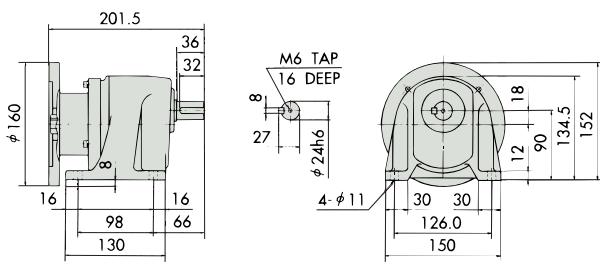

A-26 0.2kW GRTA020-42L600~1200FI

Reduction ratio : 600, 720, 1000, 1200 Approx. weight : 36.9kg
Reference page : Specification Chart→P83

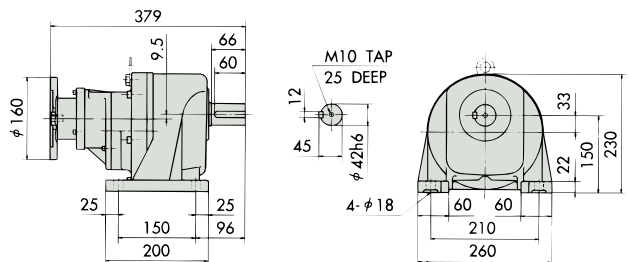

Adapter Type Outline Dimensions

0.2kW · U : Face mount type / F : Flange mount type

GEAR MOTOR TA Series

A-27 0.2kW GRTA020-18U5FI

Reduction ratio : 5 Approx. weight : 6.0kg
Reference page : Specification Chart→P83 Options→P57

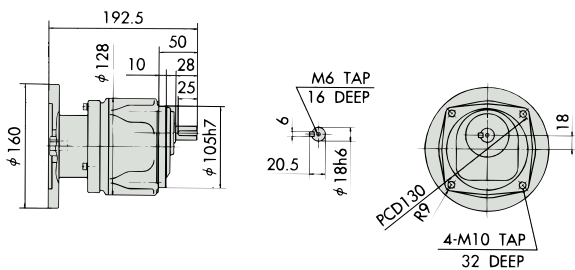

A-30 0.2kW GRTA020-28U100~200FI

Reduction ratio : 100, 120, 165, 200 Approx. weight : 8.6kg
Reference page : Specification Chart→P83 Options→P57

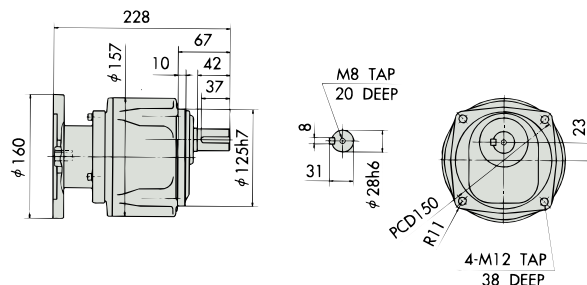

A-28 0.2kW GRTA020-18U10~25FI

Reduction ratio : 10, 15, 20, 25 Approx. weight : 4.6kg
Reference page : Specification Chart→P83 Options→P57

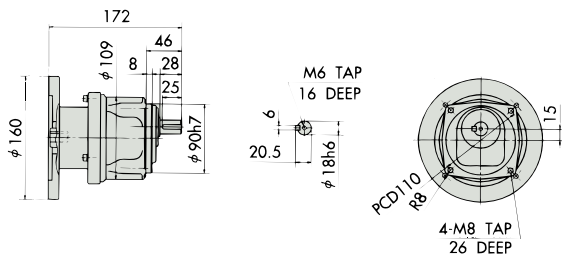

A-31 0.2kW GRTA020-38U300~450FI

Reduction ratio : 300, 360, 450 Approx. weight : 20.5kg
Reference page : Specification Chart→P83 Options→P58

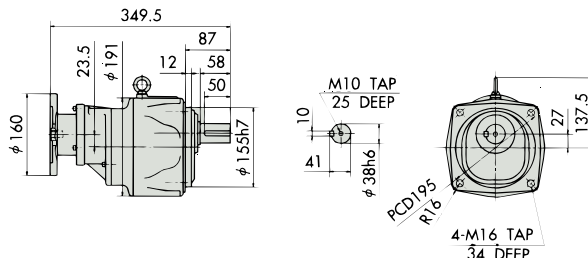

A-29 0.2kW GRTA020-24U30~75FI

Reduction ratio : 30, 40, 50, 60, 75 Approx. weight : 6.2kg
Reference page : Specification Chart→P83 Options→P57

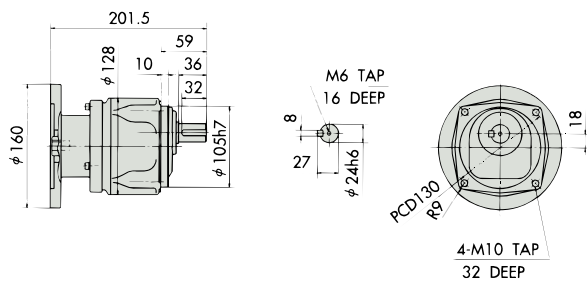

A-32 0.2kW GRTA020-42F600~1200FI

Reduction ratio : 600, 720, 1000, 1200 Approx. weight : 38.2kg
Reference page : Specification Chart→P83

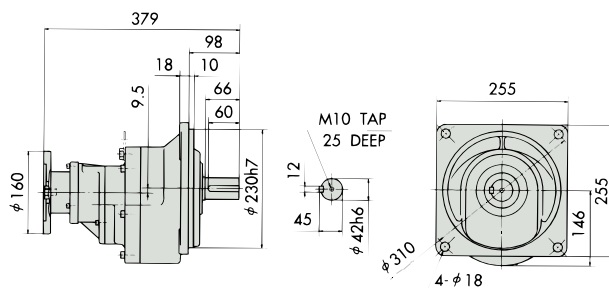

Outline Dimensions

U.F
A-27
A-28
A-29
A-30
A-31
A-32

0.2

Adapter Type Outline Dimensions

0.4kW · L : Foot mount type

GEAR MOTOR TA Series

A-33 0.4kW GRTA040-24L5~25FI

Reduction ratio : 5, 10, 15, 20, 25 Approx. weight : 6.6kg
Reference page : Specification Chart→P84

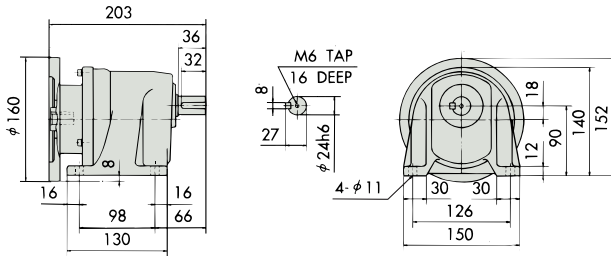

A-36 0.4kW GRTA040-42L300~450FI

Reduction ratio : 300, 360, 450 Approx. weight : 42.2kg
Reference page : Specification Chart→P84

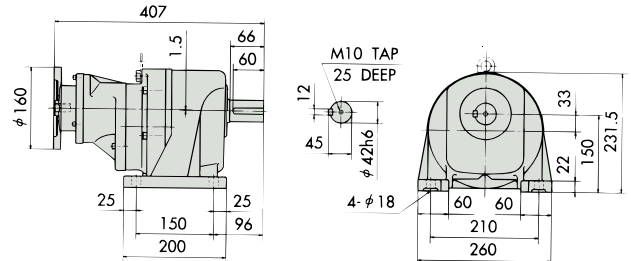

A-34 0.4kW GRTA040-28L30~75FI

Reduction ratio : 30, 40, 50, 60, 75 Approx. weight : 9.0kg
Reference page : Specification Chart→P84

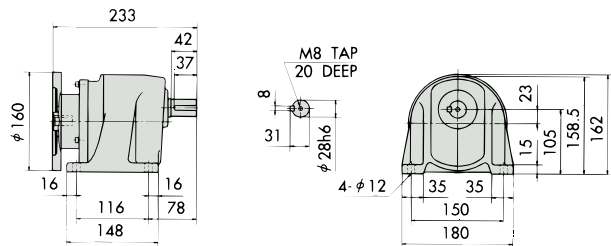

A-37 0.4kW GRTA040-50L600~1200FI

Reduction ratio : 600, 720, 1000, 1200 Approx. weight : 62.2kg
Reference page : Specification Chart→P84

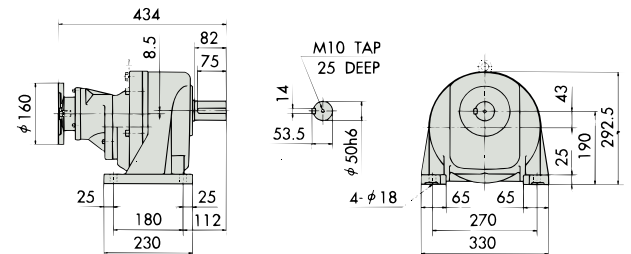

A-35 0.4kW GRTA040-38L100~200FI

Reduction ratio : 100, 120, 165, 200 Approx. weight : 13.0kg
Reference page : Specification Chart→P84

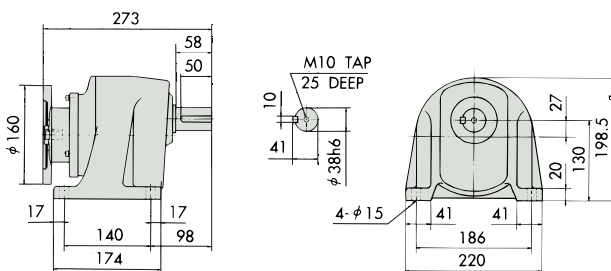

Outline Dimensions

L
A-33
A-34
A-35
A-36
A-37

0.4

Adapter Type Outline Dimensions

0.4kW · U : Face mount type / F : Flange mount type

GEAR MOTOR TA Series

A-38 0.4kW GRTA040-24U5~25FI

Reduction ratio : 5, 10, 15, 20, 25 Approx. weight : 6.6kg
Reference page : Specification Chart→P84 Options→P57

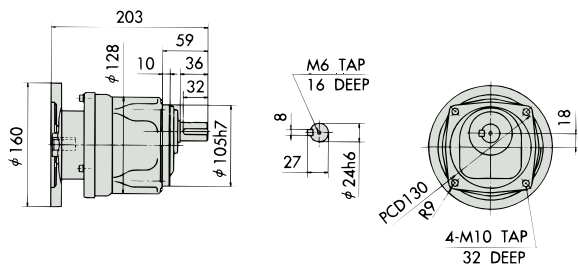

A-41 0.4kW GRTA040-42F300~450FI

Reduction ratio : 300, 360, 450 Approx. weight : 43.2kg
Reference page : Specification Chart→P84

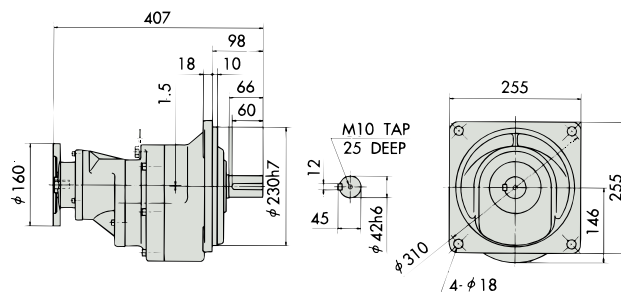

A-39 0.4kW GRTA040-28U30~75FI

Reduction ratio : 30, 40, 50, 60, 75 Approx. weight : 9.0kg
Reference page : Specification Chart→P84 Options→P57

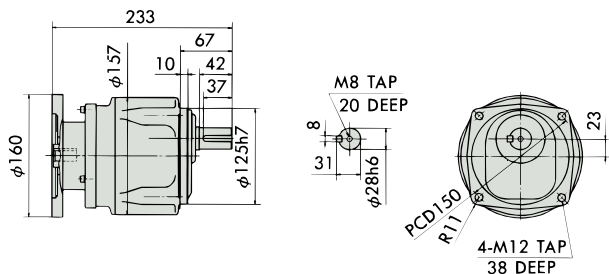

A-42 0.4kW GRTA040-50F600~1200FI

Reduction ratio : 600, 720, 1000, 1200 Approx. weight : 64.2kg
Reference page : Specification Chart→P84

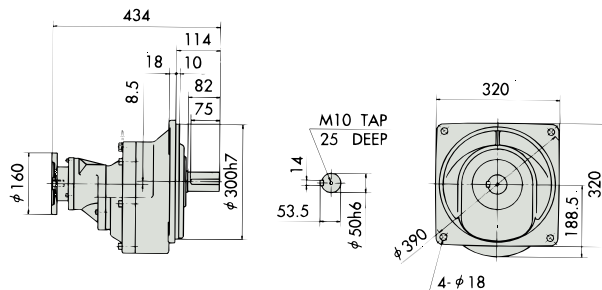

A-40 0.4kW GRTA040-38U100~200FI

Reduction ratio : 100, 120, 165, 200 Approx. weight : 19.5kg
Reference page : Specification Chart→P84 Options→P58

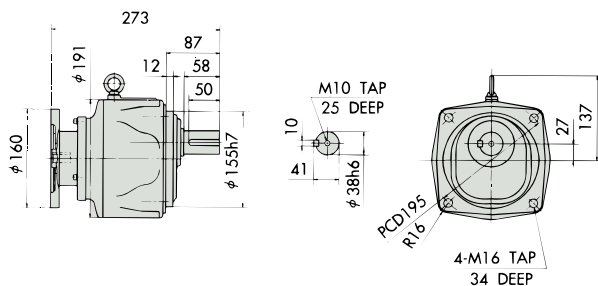

Adapter Type Outline Dimensions

0.75kW · L : Foot mount type / U : Face mount type / F : Flange mount type

GEAR MOTOR TA Series

A-43 0.75kW GRTA075-28L5~25FI

Reduction ratio : 5, 10, 15, 20, 25 Approx. weight : 11.5kg
Reference page : Specification Chart→P84

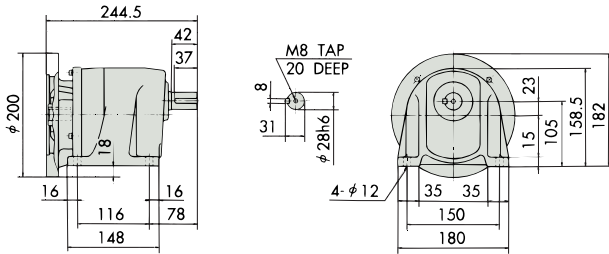

A-47 0.75kW GRTA075-28U5~25FI

Reduction ratio : 5, 10, 15, 20, 25 Approx. weight : 11.5kg
Reference page : Specification Chart→P84 Options→P57

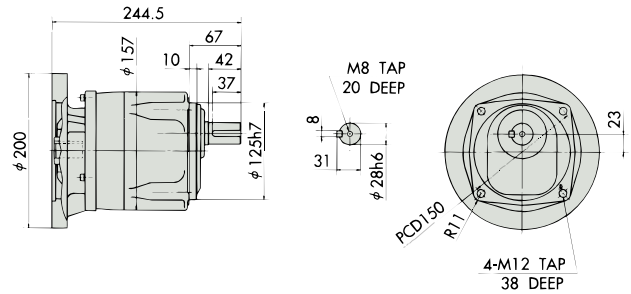

A-44 0.75kW GRTA075-38L30~75FI

Reduction ratio : 30, 40, 50, 60, 75 Approx. weight : 15.5kg
Reference page : Specification Chart→P84

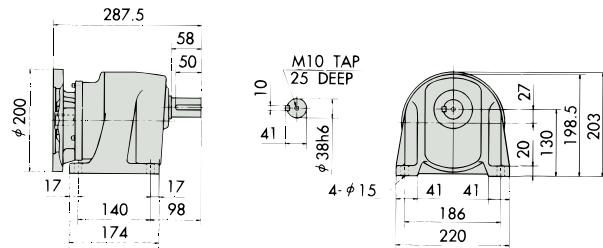

A-48 0.75kW GRTA075-38U30~75FI

Reduction ratio : 30, 40, 50, 60, 75 Approx. weight : 21.5kg
Reference page : Specification Chart→P84 Options→P58

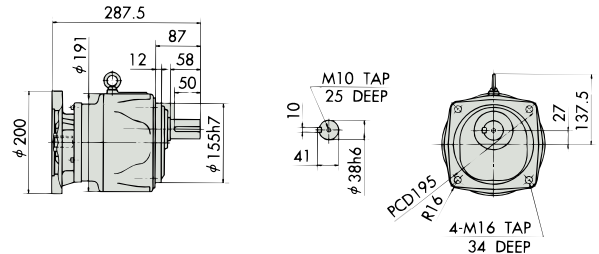

A-45 0.75kW GRTA075-42L100~200FI

Reduction ratio : 100, 120, 165, 200 Approx. weight : 37.0kg
Reference page : Specification Chart→P84

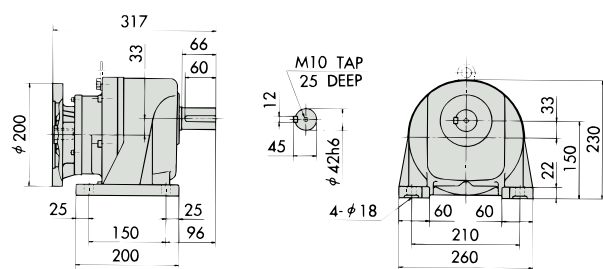

A-49 0.75kW GRTA075-42F100~200FI

Reduction ratio : 100, 120, 165, 200 Approx. weight : 39.0kg
Reference page : Specification Chart→P84

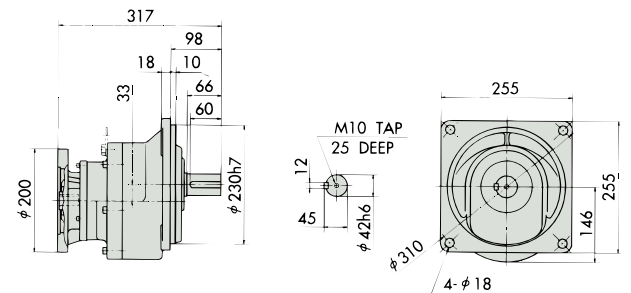

A-46 0.75kW GRTA075-50L300~450FI

Reduction ratio : 300, 360, 450 Approx. weight : 61.1kg
Reference page : Specification Chart→P84

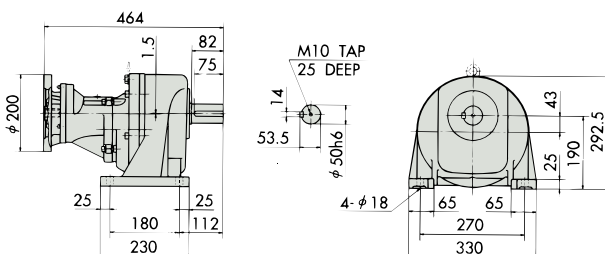

A-50 0.75kW GRTA075-50F300~450FI

Reduction ratio : 300, 360, 450 Approx. weight : 63.1kg
Reference page : Specification Chart→P84

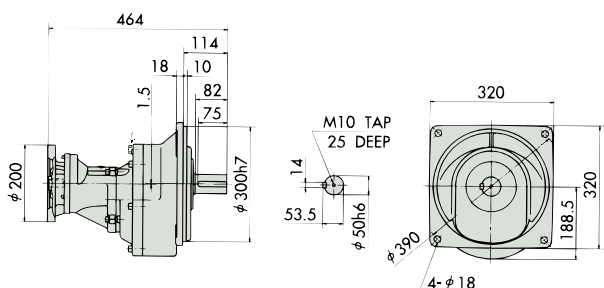

Outline Dimensions

L.U.F

A-43
A-44
A-45
A-46
A-47
A-48
A-49
A-50

0.75

Adapter Type Outline Dimensions

1.5kW · L : Foot mount type / U : Face mount type / F : Flange mount type

GEAR MOTOR TA Series

A-51 1.5kW GRTA150-38L5~30FI

Reduction ratio : 5, 10, 15, 20, 25, 30	Approx. weight : 19.0kg
Reference page : Specification Chart→P84	

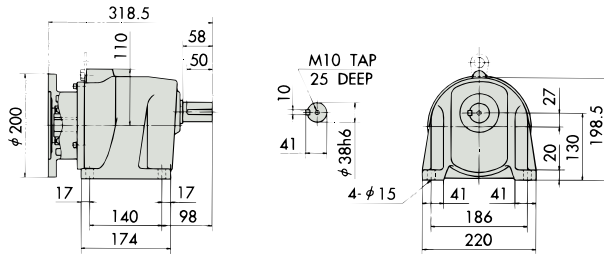

A-54 1.5kW GRTA150-38U5~30FI

Reduction ratio : 5, 10, 15, 20, 25, 30	Approx. weight : 26.0kg
Reference page : Specification Chart→P84 Options→P58	

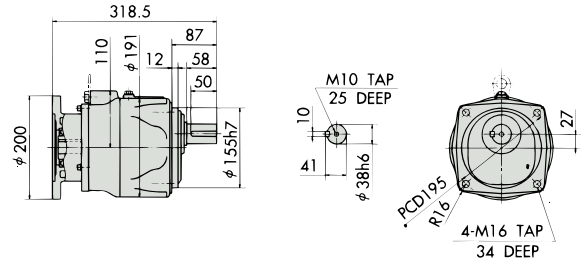

A-52 1.5kW GRTA150-42L40~75FI

Reduction ratio : 40, 50, 60, 75	Approx. weight : 40.0kg
Reference page : Specification Chart→P84	

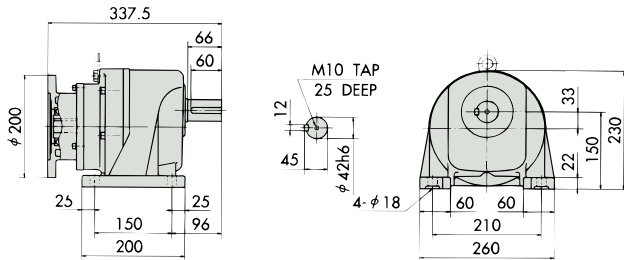

A-55 1.5kW GRTA150-42F40~75FI

Reduction ratio : 40, 50, 60, 75	Approx. weight : 41.0kg
Reference page : Specification Chart→P84	

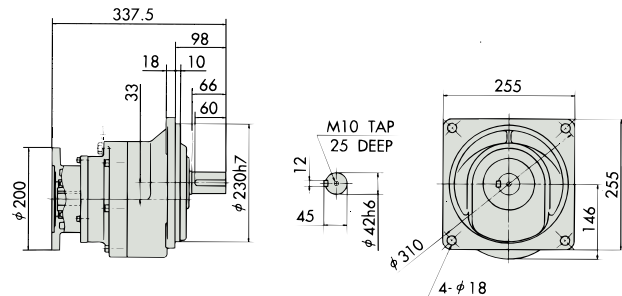

A-53 1.5kW GRTA150-50L100~200FI

Reduction ratio : 100, 120, 165, 200	Approx. weight : 60.0kg
Reference page : Specification Chart→P84	

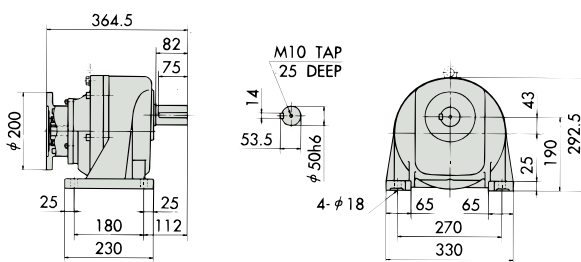

A-56 1.5kW GRTA150-50F100~200FI

Reduction ratio : 100, 120, 165, 200	Approx. weight : 62.0kg
Reference page : Specification Chart→P84	

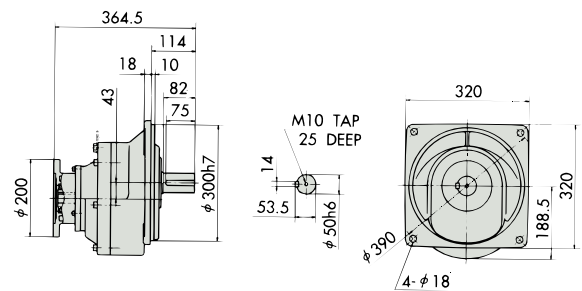

Outline Dimensions

L.U.F
A-51
A-52
A-53
A-54
A-55
A-56

1.5

Adapter Type Outline Dimensions

2.2kW · L : Foot mount type / F : Flange mount type

GEAR MOTOR TA Series

A-57 2.2kW GRТА220-42L5~30FI

Reduction ratio : 5, 10, 15, 20, 25, 30 Approx. weight : 40.0kg
Reference page : Specification Chart→P85

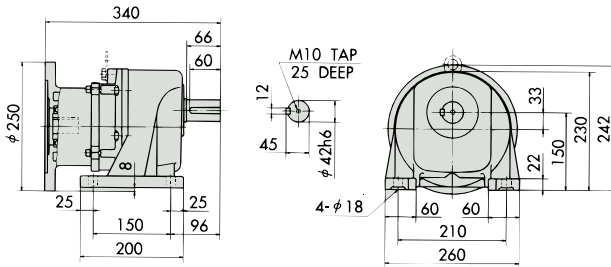

A-60 2.2kW GRТА220-42F5~30FI

Reduction ratio : 5, 10, 15, 20, 25, 30 Approx. weight : 42.0kg
Reference page : Specification Chart→P85

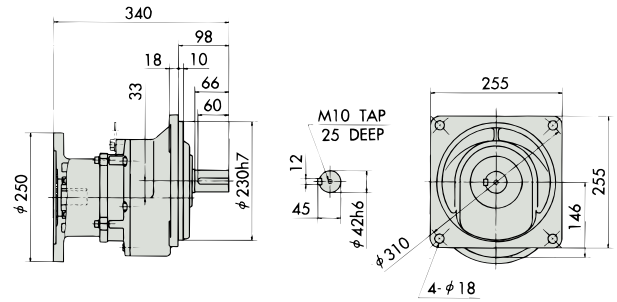

A-58 2.2kW GRТА220-50L40~75FI

Reduction ratio : 40, 50, 60, 75 Approx. weight : 61.0kg
Reference page : Specification Chart→P85

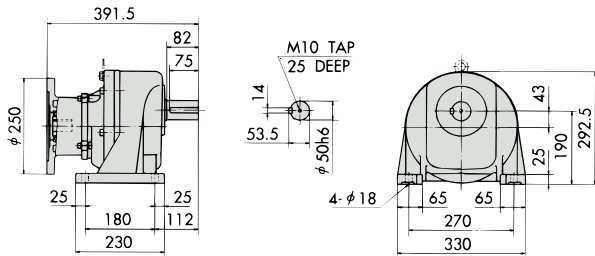

A-61 2.2kW GRТА220-50F40~75FI

Reduction ratio : 40, 50, 60, 75 Approx. weight : 64.0kg
Reference page : Specification Chart→P85

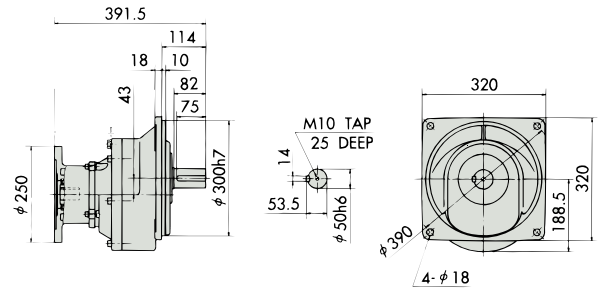

A-59 2.2kW GRТА220-63L100~200FI

Reduction ratio : 100, 120, 165, 200 Approx. weight : 92.0kg
Reference page : Specification Chart→P85

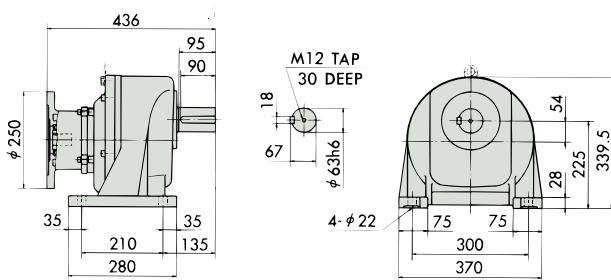

A-62 2.2kW GRТА220-63F100~200FI

Reduction ratio : 100, 120, 165, 200 Approx. weight : 96.0kg
Reference page : Specification Chart→P85

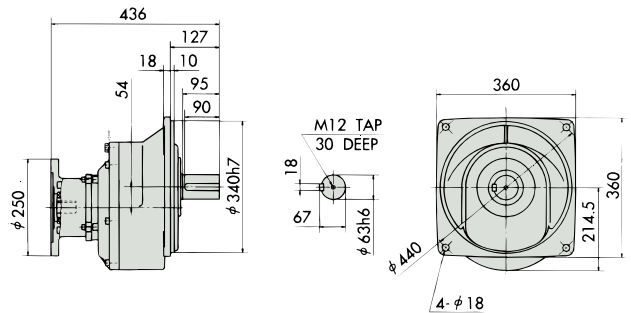

Adapter Type Outline Dimensions

3.7kW · L : Foot mount type / F : Flange mount type

GEAR MOTOR TA Series

A-63 3.7kW GRТА370-50L5~30FI

Reduction ratio : 5, 10, 15, 20, 25, 30	Approx. weight : 58.0kg
Reference page : Specification Chart→P85	

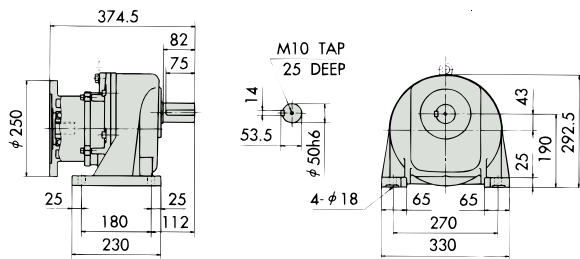

A-65 3.7kW GRТА370-50F5~30FI

Reduction ratio : 5, 10, 15, 20, 25, 30	Approx. weight : 60.0kg
Reference page : Specification Chart→P85	

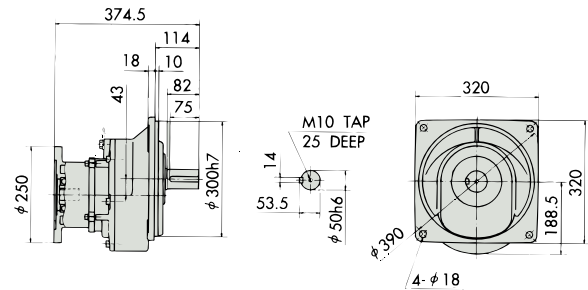

A-64 3.7kW GRТА370-50L40~50FI

Reduction ratio : 40, 50	Approx. weight : 62.0kg
Reference page : Specification Chart→P85	

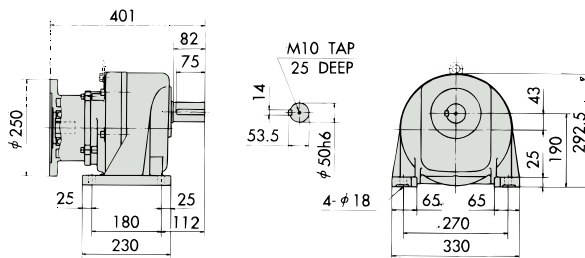

A-66 3.7kW GRТА370-50F40~50FI

Reduction ratio : 40, 50	Approx. weight : 64.0kg
Reference page : Specification Chart→P85	

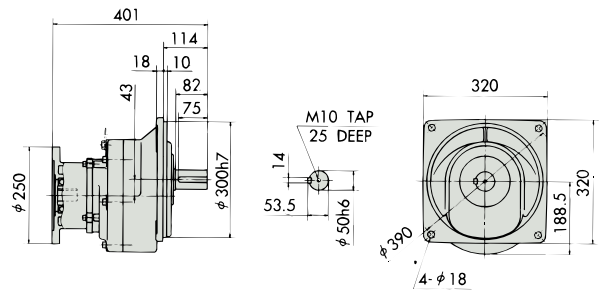

5.5kW · L : Foot mount type / F : Flange mount type

GEAR MOTOR MINI Outsize Figure ● Non-brake/Hollow axis 0.4kw

A-67 5.5kW GRТА550-50L5~30FI

Reduction ratio : 5, 10, 15, 20, 25, 30	Approx. weight : 69.0kg
Reference page : Specification Chart→P85	

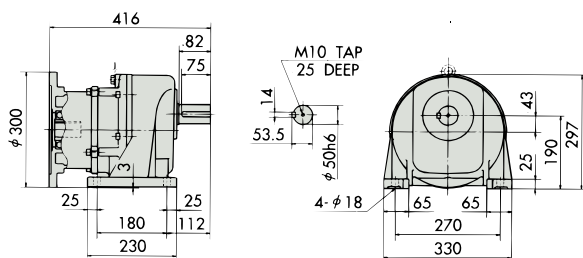

A-68 5.5kW GRТА550-50F5~30FI

Reduction ratio : 5, 10, 15, 20, 25, 30	Approx. weight : 72.0kg
Reference page : Specification Chart→P85	

