

# INSTALLATION & MAINTENANCE

For Tsubaki RS Roller Chain & RF Conveyor Chain

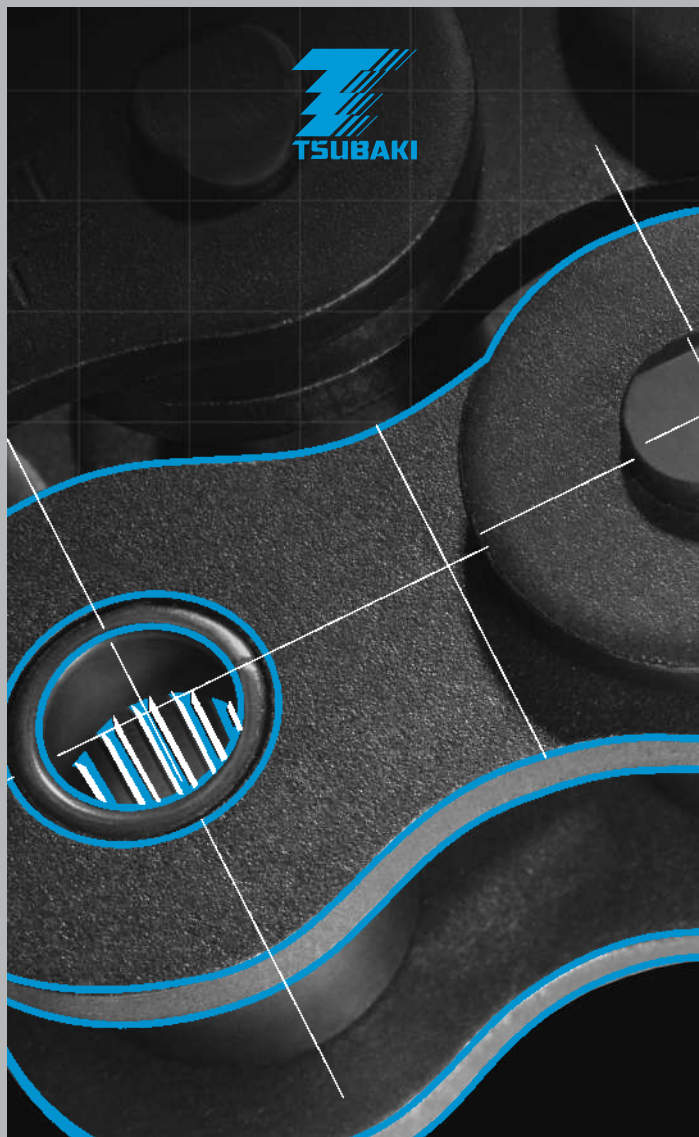

# Contents

1. Chain Construction	3
2. RS Roller Chain Connecting Links	4
3. How to Connect RS Roller Chain	5
4. How to Disconnect RS Roller Chain	6–7
5. Sprockets for RS Roller Chain	8
6. Sprocket Installation	9
7. RS Roller Chain Lubrication	10–12
8. RS Roller Chain Installation and Layout	13–15
9. RS Roller Chain Checkpoints	16–18
10. Use Under Special Conditions	19–20
11. How to Connect RF Conveyor Chain	21
12. How to Disconnect RF Conveyor Chain	22
13. RF Conveyor Chain Lubrication	23
14. RF Conveyor Chain Installation and Layout	24–25
15. Life of RF Conveyor Chain and Sprockets	26–29
16. RF Conveyor Chain Checkpoints	30
17. Warning Statement	31

# 1 Chain Construction

RS Roller Chains and RF Conveyor Chains consist of alternate connections of roller links and pin links. The roller link consists of a roller plate to which two bushings with rotating rollers are press-fit. This roller link is alternately connected to the pin link plate in which two pins have been securely press-fit.

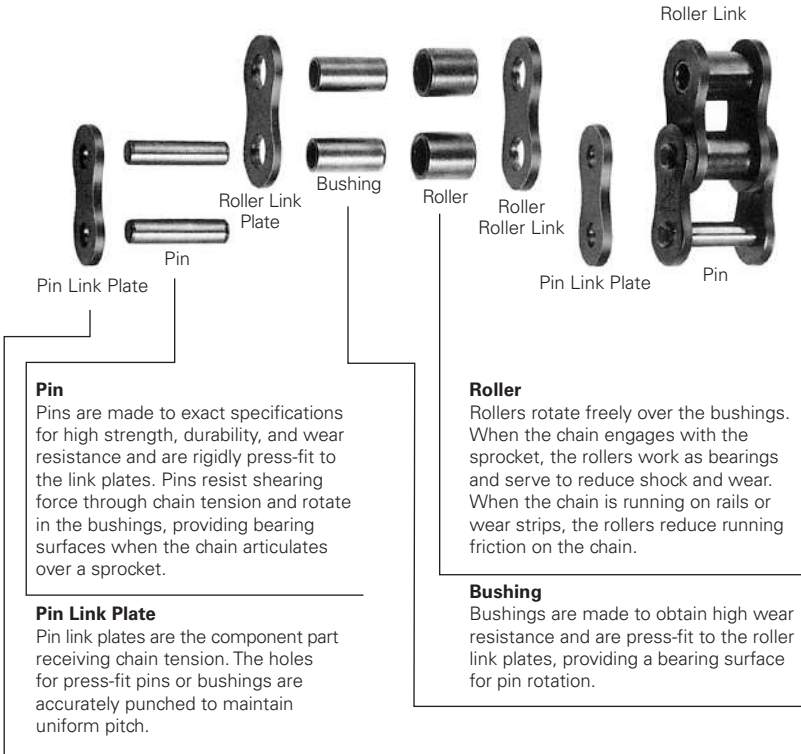

Figure 1-1: RS Roller Chain Construction

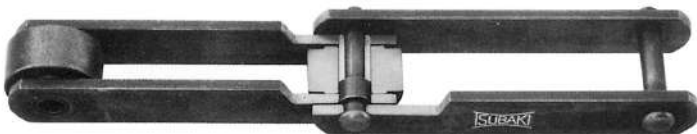

Figure 1-2: RF Conveyor Chain Construction

## 2 RS Roller Chain Connecting Links

Tsubaki Roller Chain links can be easily connected using one of two types of connecting links. Though an offset type of connecting link is available for the connection of an odd number of links, it is best to use regular links whenever possible.

### Connecting Links

Tsubaki uses two types of connecting links and, generally, two types of fasteners for RS Roller Chain:

1. A regular connecting link with either a spring clip or cotter pin type fastener
2. A special, high-performance, gold-colored connecting link also with a spring clip or cotter pin type fastener

A spring clip is used for links sized RS60 and smaller. For chain sized RS80 and larger, or for three to six strands of RS40 or RS50 chain, a cotter pin is best. A roll pin type is used for chain sized RS240.

The regular connecting link has lower fatigue strength than the gold link but is easy to use and handle. The regular type is suitable for most power transmission applications and has ample strength to withstand relatively high loads over a long period of time. The high-performance gold connecting link is preferred for severe conditions such as high impact or heavy loads and for applications with high-speed drives. The gold connecting link is durable and has fatigue strength almost equal to that of the chain itself. The gold connecting link is easily recognized by its distinctive color.



Spring Clip  
Cotter Pin  
**Figure 2-1:** Standard Connecting Link



Spring Clip  
Cotter Pin  
**Figure 2-2:** Gold-colored Connecting Link

### Offset Links

One-pitch and two-pitch offset links are available for RS Roller Chain. Two-pitch offset links consist of a roller link and an offset link with a riveted pin, as shown in Figure 2-3. The gold type connecting link can be used on both ends of the two-pitch offset link for increased capacity.

The one-pitch offset link is relatively easy to handle but should be confined to lighter loads and medium- to low-speed applications with reduced start-and-stop frequency and low-impact loads.



Two-pitch Offset Link



One-pitch Offset Link

**Figure 2-3:** Offset Links

Note: Two-pitch offset links for RS41 chain and one-pitch offset links for RS25 chain are not available.

### 3 How to Connect RS Roller Chain

#### **For easy connection and installation:**

1. Wind the chain around one of the sprockets so that the free ends are separated by one sprocket tooth.
2. Insert the connecting link into the two end links of the chain.
3. Install the free connecting link plate and fasten the plate using the spring clip or cotter pin fasteners supplied.

#### **If layout prevents the use of sprocket teeth:**

1. Wind the chain around the sprockets so that the free ends come together in the area between the sprockets.
2. Pull the chain ends together and insert the connecting link using a chain puller or by hand.
3. Install the free connecting link plate, then insert and secure the fasteners.

For both methods, be sure to tap the ends of the chain pins after the fasteners have been inserted. By tapping the ends of the pins, the fasteners will rest snugly against the outside of the connecting link plate. This will help the chain to flex freely and smoothly as it goes around the sprocket and allow better penetration of lubricant and greater fastener life.

An offset link must be used when an odd number of pitches is required. However, because the allowable working load is considerably lower than that of the base chain or standard connecting link, the use of offset links should be avoided if possible. Instead, it is better to add one link and take up the extra slack by varying the center distance between the shafts or installing an idler.

#### **Notes:**

1. The gold-colored connecting link is made to fit exactly with the pin. Do not make the link plate holes larger or the diameter of the pin smaller, as doing so may damage the chain or reduce its life and performance.
2. For cotter pin type construction, a regular pin link can be used as a substitute for the connecting link. To prevent chain damage or increased wear, the pin link must be carefully driven onto the pin parallel to the connecting link.

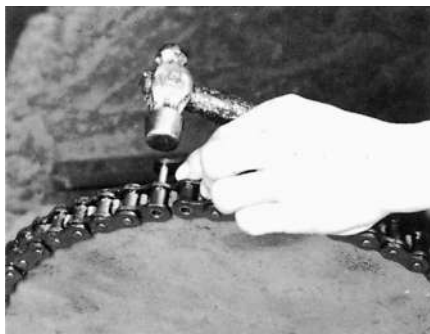

**Figure 3-1:** Connecting RS Roller Chain on a Sprocket

## How to Disconnect RS Roller Chain

There are two relatively simple methods for disconnecting RS Roller Chain. One way is to use a chain vise and punch. The other is to use a chain breaker.

### Using a Chain Vise

1. For riveted type Tsubaki Roller Chain, first grind down one end of the pin to be removed. For cotted type chain, be sure to take out the cotter pin.
2. As shown in Figure 4-1, put the chain into the vise groove and tighten the vise to secure the chain.
3. Hit the head of the pin with a punch or hammer. Be sure to hit the pins alternately for even removal.

Note: For riveted types, be sure to grind off the riveted part of the pin. If the pin is taken out without grinding, it will take more time and may damage the chain. Chain vises and punches are available for RS40 to RS240 chain.

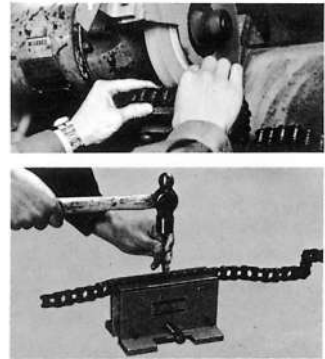

Figure 4-1: Disconnecting RS Roller Chain

Table 4-1: Chain Vise Selection

Chain No. No. of Strands	RS40	RS50	RS60	RS80	RS100	RS120	RS140	RS160	RS180	RS200	RS240
	1	CV-1									
2		CV-2				CV-3					
3										Not In Stock	

Indicates CV-1

Indicates CV-2

Indicates CV-3

Notes:

1. For overlapping parts, a smaller chain vise is easier to use.
2. These chain vises can also be used for double-pitch chain other than RS Roller Chain.

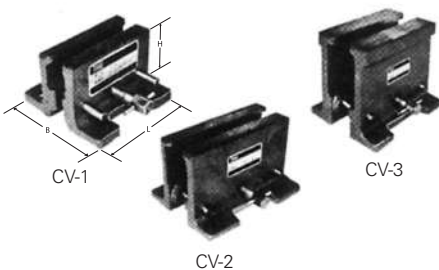

Figure 4-2: Chain Vise Types

Table 4-2: Chain Vise Dimensions mm (in.)

Type	L	H	B
CV-1	100	65	94 ~ 115
	(3.94)	(2.56)	(3.70 ~ 4.53)
CV-2	180	110	120 ~ 151
	(7.09)	(4.53)	(4.72 ~ 5.94)
CV-3	200	170	180 ~ 220
	(7.87)	(6.69)	(7.09 ~ 8.66)

### Using a Chain Punch

When using a chain punch, be sure to draw both pins out together. Link plates cannot be used again once the pins have been removed.



Figure 4-3: Punch Selection

Table 4-3: Punch Selection

Chain No.	Primary Punch	Secondary Punch	Riveting Punch
RS40 ~ RS60	S-1	D-1	For RS40
RS80 ~ RS120	S-2	D-2	For RS50
RS140 ~ RS240	S-3	D-3	For RS60
			For RS80

### Using a Chain Breaker

A chain breaker is a tool made for cutting chain. The chain breaker does not require a firm working table and can cut chain already set on a machine. RS25 and RS35 chains require a chain breaker.

Table 4-4: Chain Breaker Selection

Chain No. No. of Strands	RS25	RS35	RS41	RF06B	RS40	RS50	RS60	RS80	RS100	RS120	RS140	RS160	RS180	RS200	RS240
	1	CS-A1	CS-A2	CS-A3	CS-A4	CS-B1		CS-C1		CS-C2		CS-C3			
2															

Notes:

- A4 type, B type, C type, and two-strand A type are made to order; all others are from stock.
- This series can also be used with BS Roller Chain and Tsubaki Marine Chain. A specially manufactured breaker for Marine Chain is also available.

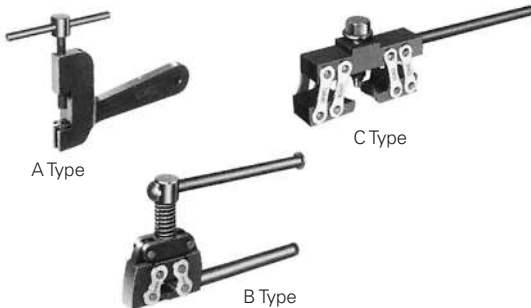

Figure 4-4: Chain Breaker Types



Figure 4-5: Using the Chain Breaker

## 5 Sprockets for RS Roller Chain

Good quality sprockets are essential for maximum power transmission efficiency. The tooth configurations of Tsubaki Sprockets conform to JIS and ANSI standards. All Tsubaki Sprockets are precision components with finely balanced boss and rim parts that are exactly in accordance with Tsubaki of Canada Limited stated specifications.

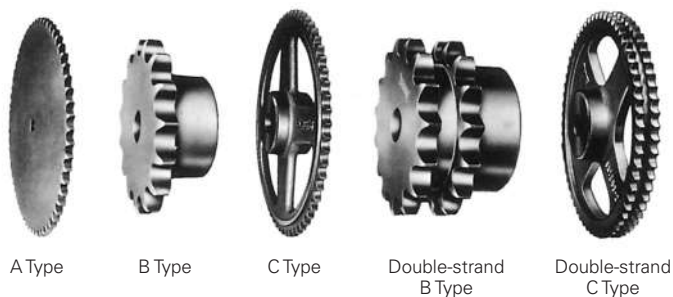

Figure 5-1: Sprocket Types

### Sprocket Materials

Suitable sprocket materials should be selected according to the working conditions and requirements of the application. Proper selection will result in higher performance and better cost-effectiveness.

Table 5-1: Sprocket Materials

Sprocket Type	Material
A Type	Low Carbon Steel
B Type	High Carbon Steel
C Type	Ductile Cast Iron (RS40~RS120) Cast Iron (RS140~RS160)

### High Frequency Hardening for Tips of Sprocket Teeth

Roller chain is often used for high-speed power transmission. For these applications, use standard sprockets with fewer teeth that have been hardened at the tooth tips by high frequency hardening, such as single-row, B Type Sprockets for RS35~RS100 chain and double-row, B Type Sprockets for RS40~RS100.

### Hardening for the tips of sprocket teeth is required in the following cases:

1. For sprockets with up to 24 teeth used at speeds of more than one-eighth of the maximum speed specified for RS Roller Chain
2. For small sprockets and speed ratios of more than 1:4
3. For use with heavy loads at low speeds
4. For use in abrasive conditions

### Shaft Hole Processing

If the shaft hole is to be processed by the customer, processing should be based on the tooth bottom. Keyway and shaft hole dimensions are required for processing done by Tsubaki of Canada Limited.



## 6 Sprocket Installation

Careful and accurate sprocket installation is required for smooth operation and maximum chain and sprocket life.

### Sprocket Alignment

1. Level each shaft, checking the adjustment with a level applied directly to the shaft. The incline should be adjusted within the range of  $\pm 1/300$ .



Figure 6-1: Shaft Alignment

2. Align the shaft for parallelism using a scale. Parallelism of the shafts should be adjusted so that the incline is within the range of  $\pm 1/300$  (A-B/L).

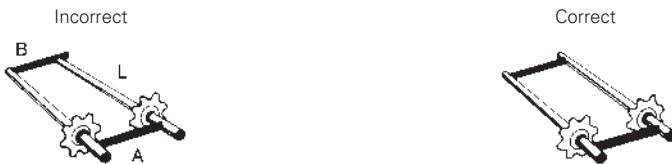

Figure 6-2: Shaft Parallelism

3. Check the axial alignment of the sprocket using a straightedge or scale. The following are the tolerances based on the distance between the shafts.

Up to 1 m (3.3 ft.):  $\pm 1$  mm (0.04 in.)

1 m (3.3 ft.) to 10 m (33 ft.):  $\pm$  Distance between 2 shafts/1,000

More than 10 m (33 ft.):  $\pm 10$  mm (0.39 in.)



Figure 6-3: Axial Alignment

4. Attach the sprockets using keys, collars, set bolts, etc., as necessary.

## 7 RS Roller Chain Lubrication

All Tsubaki Roller Chain is pre-lubricated with a special high-grade lubricant before packing. Tsubaki's lubricant has been specially developed to thoroughly penetrate all parts of the chain, especially the critical areas where the pin and bushing surfaces articulate with each other while the chain is under a full load.

Proper roller chain lubrication is essential for peak performance and maximum chain life. Follow the lubrication schedule and recommendations carefully. Improper lubrication will shorten chain life and decrease operating performance.

Since wear between pins and bushings causes chain elongation, lubrication must be maintained on all contact surfaces. Proper lubrication forms an oil film that:

1. Reduces abrasion and chain wear
2. Reduces chain friction and noise
3. Functions as a coolant when chain is run at high speeds
4. Functions as a cushion against impact

Lubricant for roller chain must be selected and applied according to the application and working conditions of the chain. Once applied, the lubricant should not be wiped off with a cloth or washed with certain solutions, such as TriClean™.

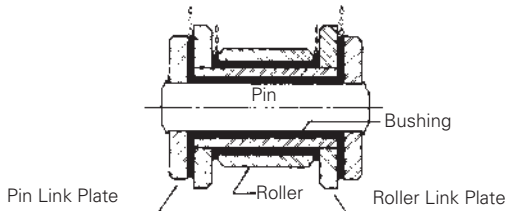

**Figure 7-1:** Proper Penetration of Lubricant

The lubricant should penetrate the areas shown in Figure 7-1.

### Recommended Lubricants

Only high-grade oil of suitable viscosity should be used for RS Roller Chain lubrication. The amount and type of oil depends on the chain specifications, working conditions, and lubricating system.

### Oils to avoid:

1. Heavy oil (except under special conditions)
2. Low-grade oil
3. Impure oil or grease
4. Used oil

These types of oil should not be used as they do not lubricate the chain effectively and will reduce service life or cause chain damage or breakage.

TriClean™ is a trademark of TriSep Corporation, Goleta, CA.

**Table 7-1: Lubrication Selection**

Temperature is in °C (°F)

Lubricating System Temp. Chain No.	A, B				C			
	-10°~0° (14°~32°)	0°~40° (32°~104°)	40°~50° (104°~122°)	50°~60° (122°~140°)	-10°~0° (14°~32°)	0°~40° (32°~104°)	40°~50° (104°~122°)	50°~60° (122°~140°)
RS50 or smaller	SAE 10	SAE 20	SAE 30	SAE 40	SAE 10	SAE 20	SAE 30	SAE 40
RS60 and RS 80	SAE 20	SAE 30	SAE 40	SAE 50				
RS100					SAE 20	SAE 30	SAE 40	SAE 50
RS120 or larger	SAE 30	SAE 40	SAE 50					

**Lubricating System and Quantity of Oil Applied**

The following lubricating systems are recommended. Refer to the Tsubaki of Canada Limited Guide to Products and Specifications for system selection.

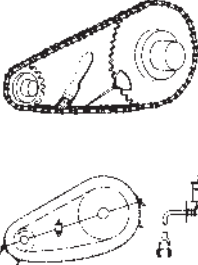
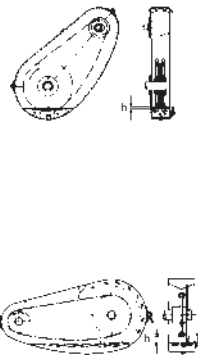
	Method	Quantity of Oil
<p>System A</p> 	<p><b>Manual Application</b> Oil is applied with an oil filler or brush to the slack side of the chain.</p>	Oil should be applied at a fixed interval, generally about every eight hours, or as often as necessary to prevent the bearing areas from becoming dry.
	<p><b>Drip Lubrication</b> A simple case can be used. Oil from the oil cup is supplied by drip feeding.</p>	Five to 50 drops of oil per minute are necessary for every strand of chain. Actual quantities depend on operating speed.
<p>System B</p> 	<p><b>Oil Bath Lubrication</b> The chain is installed in a leak-free casing.</p>	Depth "h" from oil surface to chain should be 6 mm (.25 in.) to 12 mm (.50 in.). If "h" is too high, the composition of the oil may change due to the heat generated and reduce its effectiveness.
	<p><b>Lubrication by Rotating Disc</b> Oil can be splashed on the chain using a rotating disc installed in a leak-free casing. For this method, speed along the circumference of the disc should be more than 200 m/min. (656 ft./min.). If chain width is more than 124 mm (4.9 in.), use a rotating disc on both sides.</p>	The clearance "h" between the oil surface and the lowest position of the chain should be from 12 mm (.50 in.) to 25 mm (1.0 in.).

	Method	Quantity of Oil
System C 	<b>Lubrication by Pump</b> The chain is contained in a leak-free case and a pump is used to circulate and cool the oil. When the number of chain strands is "n," "n + 1" lubrication supply holes are necessary.	Oil should be supplied according to Table 7-2.

**Table 7-2:** Quantity of Oil for Lubrication Using a Pump

ℓ/min. (gal./min.)

Chain Speed m/min. (ft./min.)	Chain No.			
	RS60 and smaller	RS80 ~ RS100	RS120 ~ RS140	RS160 and larger
500 ~ 800 (1,600 ~ 2,600)	1.0 (0.26)	1.5 (0.40)	2.0 (0.53)	2.5 (0.66)
800 ~ 1,100 (2,600 ~ 3,600)	2.0 (0.53)	2.5 (0.66)	3.0 (0.79)	3.5 (0.92)
1,100 ~ 1,400 (3,600 ~ 4,600)	3.0 (0.79)	3.5 (0.92)	4.0 (1.06)	4.5 (1.19)

Regardless of the lubricating system used, roller chain should be washed periodically with petroleum or gasoline. Examine the pin and bushing to confirm the effectiveness of the lubrication. The appearance of a red or reddish-brown color is usually the result of insufficient lubrication.

### Speed Ratio and Chain Lap

The speed ratio of RS Roller Chain can range up to 7:1 under normal conditions. However, a speed ratio of 10:1 is possible if the required speed is very slow. Chain lap on the small sprocket must be at least 120 degrees.

### Distance Between Shafts

Optimum distance between sprockets is 30 to 50 times the pitch of the chain, except when there is a pulsating load. In such cases, the distance can be up to 20 times the pitch of the chain.

### Layout

When arranging the roller chain drive, the centerline of both sprockets should be as close to horizontal as possible, though the angle of installation can be up to 60 degrees. If installation is close to vertical, slight chain elongation can cause the chain to easily slip off the sprockets. In this case, an idler or guide stopper is recommended.

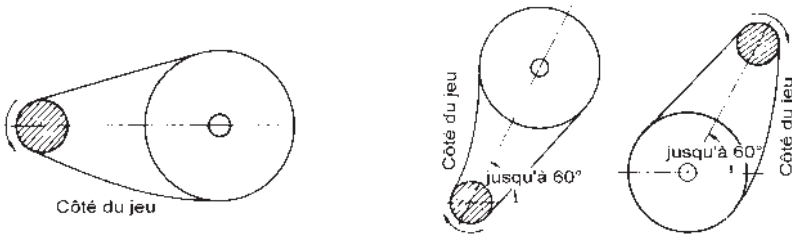

Figure 8-1: General Arrangement

Note: Driving shaft is shown by oblique lines.

It is best to keep the angle of installation within 60 degrees. If the angle must be more than 60 degrees, refer to the instructions for vertical centerlines (No. 3) in the next section.

### Layouts Requiring Attention

1. If the slack side is on top, consider the following to eliminate extra chain slack:  
If the driving distance is short, adjust the center distance between the sprockets.

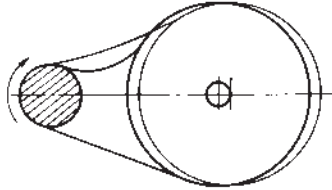

**Figure 8-2:** Short Driving Distance

If the driving distance is long, adjust chain slack by installing an idler as shown in Figure 8-3.



**Figure 8-3:** Long Driving Distance

2. For pulsating loads caused by high chain speed:

A stopper will help to prevent vibration. Chain vibration is often caused by the tune of the chain's individual frequency, by the impact period of the driven shaft, or by chordal action of the chain.

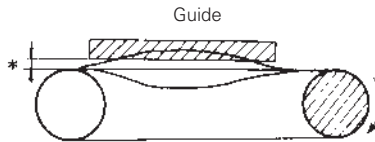

\*Clearance between the chain and guide stopper should be 2 mm (.781 in.) to 4 mm (.156 in.).

**Figure 8-4:** Guide Stopper

3. For vertical centerlines:

Install an idler to eliminate extra chain slack. When the driving shaft is on the lower side (A), an idler is essential.

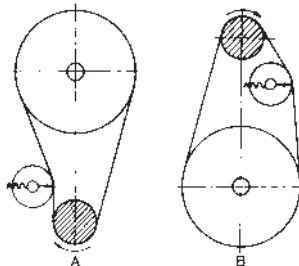

**Figure 8-5:** Vertical Centerlines

## Roller Chain Tension

Initial tension for roller chain power transmission is not as critical as for belt transmission. Generally, roller chain is used with adequate slack. Slack on the lower side is most desirable.

If the chain is excessively tight, chain damage or rapid use of lubricant may result. If the chain is too loose, damage due to vibration or chain winding may result.

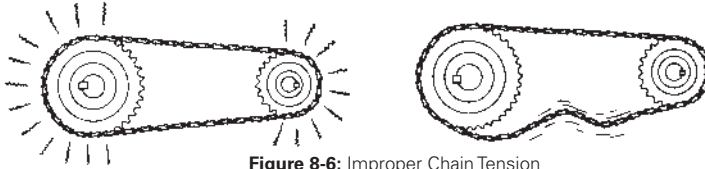

Figure 8-6: Improper Chain Tension

Slack ( $S$ 's) should be adjusted to four percent of the chain span ( $AB$ ). For example, if the chain span is 800 mm (31.5 in.), slack should be:  $800 \text{ mm (31.5 in.)} \cdot 0.04 = 32 \text{ mm (1.26 in.)}$

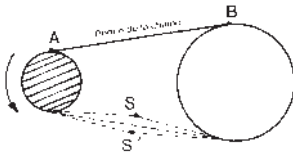

Figure 8-7: Measuring Chain Slack

Slack should be adjusted to approximately two percent in the following situations.

- 1) Vertical power transmission (idler is required)
- 2) Distance between the shafts is more than 1 m (3.3 ft.)
- 3) Heavy loads and frequent starting
- 4) Sudden backward rotation

The chain will elongate slightly from the beginning of initial operation from 0.05 to 0.1 percent of the full length. As this causes extra slack, adjustment is required. A tensioner can be used to take up the slack or the shaft can be adjusted to minimize chain elongation.

## Trial Run

A trial run should be performed before regular operation to check for the following:

1. Proper fit of the connecting link plate (and spring clip or cotter pin)
2. Adequate chain slack
3. Sufficient lubrication
4. No contact between chain and its case
5. No abnormal noise
6. No excessive vibration
7. Chain does not wind around the sprocket
8. No kinks or stiff chain parts

If any problems are discovered, re-install the chain and sprocket, referring to the checkpoints on pages 16 and 17.

## 9 RS Roller Chain Checkpoints

Chain life is generally considered to have expired when the chain does not engage properly with the sprocket due to elongation or damage of its parts. When this occurs, it is usually necessary to replace the chain.

A long, trouble-free working life can be achieved if chain is properly selected for the conditions of its application. To help prevent damage or premature wear, inspect the chain and sprockets for:

1. Abnormal noise
2. Chain vibration
3. Chain rising on the sprocket
4. Chain winding around the sprocket
5. Kinks or stiff bending of chain
6. Amount and state of lubrication
7. Contact between chain and case
8. Chain appearance. Check for dirt, corrosion, damage on the outside surface of the roller, contact marks, etc. Also check the inside edge and surfaces of the link plates and the surface edges of the pins
9. Damage on the sprocket tooth surfaces and side surface teeth and engaging areas
10. Abrasive stretch of the chain
11. Bending of chain and rotation of roller

### Checkpoints

#### 1. Lubrication

While the chain is in operation, check that the lubricating oil moves toward the link plates and that the chain or rotating disc is immersed in the oil bath. When the chain is stopped, check for dirt or abrasive particles produced by improper lubrication. When the chain is removed, the connecting link pin and the inside edge of the bushing should be checked. Damage or a red or reddish-brown color signal improper or insufficient lubrication.

#### 2. Link Plate

Chain exposed to repeated loads over the allowable load can develop fatigue breaks in the link plate. Fatigue breaks are difficult to anticipate until they produce a crack. Cracks usually develop at the edge of a hole or at the side of the link plate as shown in Figures 9-1 and 9-2. Check link plates often for cracks to prevent accidents.



**Figure 9-1:** Positions where Cracks are Likely to Develop



**Figure 9-2:** Example of an Expanding Crack



### 3. Roller Link

Care should be taken to avoid repeated impact loads over the allowable load as fatigue breaks may occur. The roller should be checked in the same way as the link plate. If foreign objects interfere with the engagement of the roller and sprocket, the roller may be damaged and a crack may develop. Chains damaged by fatigue breaks must be replaced.



Figure 9-3: Crack Produced on the Roller

### 4. Sprocket

Chain and sprocket engagement can be checked by observing the roller and sprocket tooth surfaces. A proper margin (A) and improper margin (B) are shown in Figure 9-4. Installation should also be checked. Normal margin position is slightly above the tooth bottom. If tension remains on the slack side, the roller will touch the tooth bottom slightly. If an idler or tightener is used, the margin will be at the center of the tooth bottom.

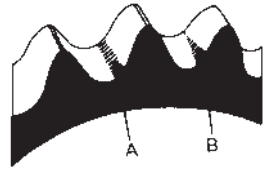

Figure 9-4: Areas to Check for Sprocket Wear

### 5. Chain Elongation

Chain stretch is calculated as the total amount of elongation caused by wear on the pin and bushing, not including deformation of the link plate. Measuring chain elongation can help estimate the remaining life of the chain.

#### Measuring Chain Elongation

1. Stretch the chain slightly.
2. To get distance (L), use a vernier to measure the distance of the inside ( $L_1$ ) and outside ( $L_2$ ) of the rollers at both ends of the measured links.

$$L = \frac{L_1 + L_2}{2}$$

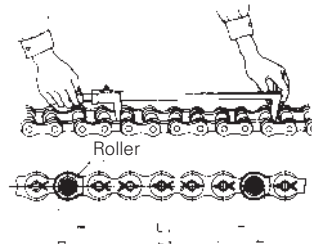

Figure 9-5: Measuring Chain Elongation

3. Use the following equation to calculate chain elongation:

$$\text{Chain Elongation (L)} = \frac{(\text{Measured Length} - \text{Standard Length})}{\text{Standard Length}} \times 100(\%)$$

Where:

Standard Length = Chain Pitch X Number of Links

Note: Measure at least six to ten links to minimize errors. A tape measure can be used if a vernier is not available. Because tape measures are less accurate, the measured length should be as long as possible.

**Table 9-1:** Maximum Allowable Chain Elongation

No. of Teeth of Driving Sprocket	Chain Elongation (%)
60 or less	1.5
61 ~ 80	1.2
81 ~ 100	1.0
100 or more	0.8

**Table 9-2:** Standard Length and 1.5% Elongation

mm (in.)

No. of Links	Length	RS25	RS35	RS41	RS40	RS50	RS60	RS80
6	Standard	38.10 (1.50)	57.15 (2.25)	76.20 (3.00)	76.20 (3.00)	95.25 (3.75)	114.30 (4.50)	152.40 (6.00)
	1.5% Elongation	38.67 (1.52)	58.01 (2.28)	77.34 (3.05)	77.34 (3.05)	96.68 (3.81)	116.01 (4.57)	154.69 (6.09)
10	Standard	63.50 (2.50)	95.25 (3.75)	127.00 (5.00)	127.00 (5.00)	158.75 (6.25)	190.50 (7.50)	254.00 (10.00)
	1.5% Elongation	64.45 (2.54)	96.68 (3.81)	128.91 (5.08)	128.91 (5.08)	161.13 (6.34)	193.36 (7.61)	257.81 (10.15)
No. of Links	Length	RS100	RS120	RS140	RS160	RS180	RS200	RS240
6	Standard	190.50 (7.50)	228.60 (9.00)	266.70 (10.50)	304.80 (12.00)	342.90 (13.50)	381.00 (15.00)	457.20 (18.00)
	1.5% Elongation	193.36 (7.61)	232.03 (9.14)	270.70 (10.66)	309.37 (12.18)	348.04 (13.70)	386.72 (15.23)	464.06 (18.27)
10	Standard	317.50 (12.50)	381.00 (15.00)	444.50 (17.50)	508.00 (20.00)	571.50 (22.50)	635.00 (25.00)	762.00 (30.00)
	1.5% Elongation	322.26 (12.69)	386.72 (15.23)	451.17 (17.76)	515.62 (20.30)	580.07 (22.84)	644.53 (25.38)	773.43 (30.45)

### Checking Chain Accessories

Check for damage to any metal fittings and make sure fittings are as secure as possible. Loose-fitting attachments may reduce the life of the chain. Generally, a tolerance up to H8 or H9 is permitted for the pin hole diameter.

## 10 Use Under Special Conditions

Generally, roller chain should be used in relatively clean air and in temperatures of 10°C to 60°C (50°F to 140°F). Refer to the chart below when operating outside this temperature range.

Ambient Temperature	Comments
-50°C ~ -30°C (-60°F ~ -20°F)	Use a special cold-resistant material.
-30°C ~ -10°C (20°F ~ -15°F)	<ol style="list-style-type: none"> <li>1. Use a lubricating oil for extremely low temperatures.</li> <li>2. Power transmission efficiency will be reduced.</li> </ol>
60°C ~ 150°C (140°F ~ 300°F)	Use a lubricating oil for high temperatures.
150°C ~ 260°C (300°F ~ 480°F)	<ol style="list-style-type: none"> <li>1. Use a lubricating oil for very high temperatures.</li> <li>2. Since the wear resistance of the chain is reduced, a larger chain size is recommended.</li> </ol>
260+°C (480+°F)	<ol style="list-style-type: none"> <li>1. Use a lubricating oil for extremely high temperatures.</li> <li>2. Heat-resistant steel must be used or chain hardness will decrease and chain strength will be significantly reduced.</li> </ol>

### Use in Wet Conditions

If a chain is splashed with water or runs through heated vapor, such as in a sterilizing machine or water screen, the following problems may occur:

1. An increase in abrasive stretch due to improper or insufficient lubrication.
2. Shortened chain life due to oxidation of the chain material.

In such cases, take the following measures:

1. Decrease bearing pressure by using a larger chain size.
2. Use plated or stainless steel chain.
3. Use a more suitable lubricant.

**Use in Acidic or Alkaline Conditions**

Exposure to acids will increase chain wear. Brittleness and breakage may occur when standard mechanical abrasion is compounded by chemical corrosion. Acids are more damaging to chain than alkali. Electrochemical corrosion caused by seawater or pit water may also occur. In these cases, chain should be plated or manufactured with corrosion resistant materials.

**Use in Abrasive Conditions**

Abrasion occurs when sand, coke, metal particles, or dust in the air becomes embedded in the moving or engaging parts of the chain and sprocket. Take the following steps when operating under these conditions:

1. Reduce bearing pressure by using a larger chain size.
2. Increase wear resistance by applying special processing to the parts of the chain where abrasion is a problem.

## 11 How to Connect RF Conveyor Chain

Unless otherwise specified, new conveyor chains are usually supplied in 3 m (10 ft.) lengths to facilitate handling. The chains are manufactured in even numbers of pitches, with an inner link at one end and an outer link at the other end for easy joining.

### To connect the chain:

1. First, fit the pin holes of the outer link plate to the bushing holes to be connected and insert the pins.



Figure 11-1: Inserting the Pins

2. Hold the counter plate with a hammer (A) and tap the pin heads with another hammer (B) until the pins are completely inserted into the link plate.

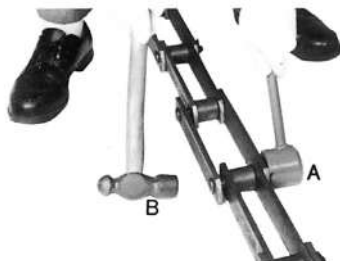

Figure 11-2: Putting on the Link Plate

3. Insert new T-pins or cotter pins into the bearing pins and bend the ends to prevent them from coming loose.



Figure 11-3: Inserting New T-pins or Cotter Pins

4. Check that the chain has smooth flexibility and is free of kinks.

## 12 How to Disconnect RF Conveyor Chain

Like RS Roller Chain, RF Conveyor Chain from Tsubaki can be easily taken apart, either manually or with a vise or chain breaker.

1. Begin by removing the bent T-pins or cotter pins where the chain is to be cut.

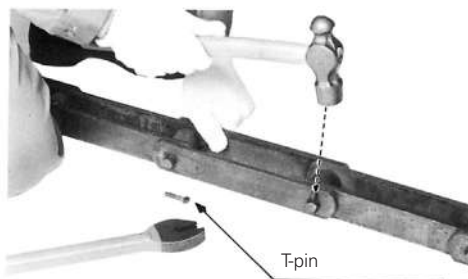

**Figure 12-1:** Removing the T-pins or Cotter Pins

2. Hold the link plate on the pin head side with a tool and from the opposite side, tap the pin with a hammer until it dislodges.

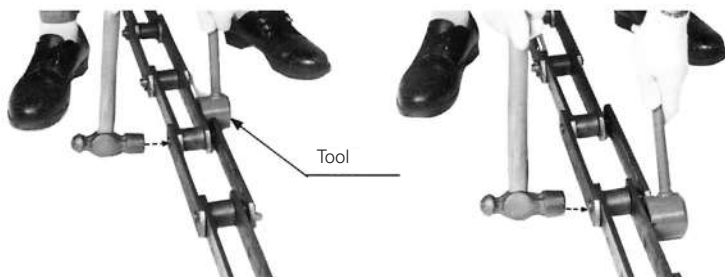

**Figure 12-2:** Dislodging the Pins

3. Now the chain can be disconnected.

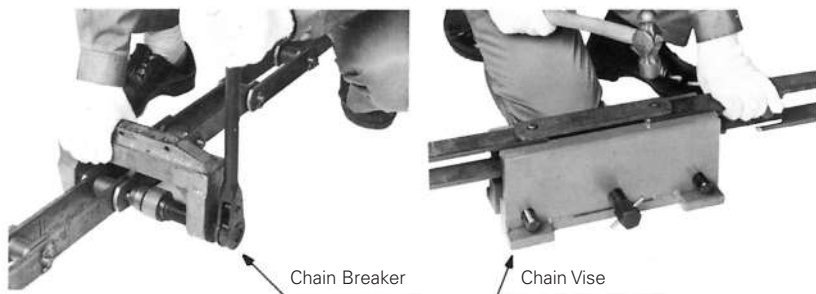

**Figure 12-3:** Using a Chain Breaker and Chain Vise

As with other power transmission chains, Tsubaki Conveyor Chains require proper lubrication. Good lubrication reduces wear, economizes horsepower, and reduces chain pulsation. Lubrication should be applied once per week by dripping or brushing Turbine Oil #75 - #120 into crevices as shown in Figure 13-1. For conveyor chains with grease pockets, grease should typically be supplied every six months.

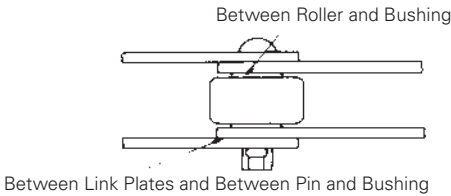

**Figure 13-1:** Important Conveyor Chain Lubrication Points

### Automatic Lubrication System

An automatic lubrication system can be used to save labor or when system configurations prevent manual lubrication.

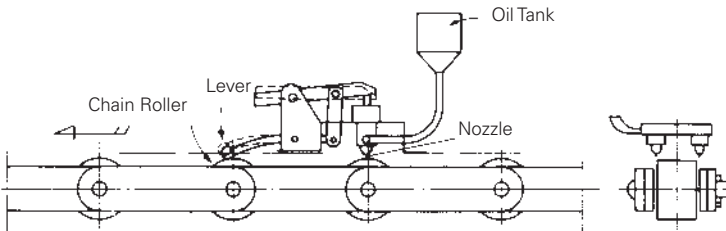

**Figure 13-2:** Automatic Drip Lubrication

The automatic drip lubrication system pictured in Figure 13-2 utilizes the chain roller as a cam. The roller pushes up a pump lever as it passes by, causing the oil to drip.

This lubricator, however, cannot be used when the conveyor chain functions as an overhead trolley conveyor or when the chain requires many lubrication points. In these cases, a mist type lubricator operated by compressed air is recommended. For coil conveyor chain, an automatic grease feeder is available.

### Where Lubrication is Ineffective

In most cases, lubrication is ineffective for bulk conveyors that convey powdery and granular materials. For flow or trough conveyors, the chain buries itself in the material as it moves in the conveying direction. Dust or other particles can become embedded in the chain and reduce or eliminate the lubricant effects of the oil.

### Adjustment of Chain Tension

The correct amount of chain slack is essential for proper chain operation. When the chain is too tight, working parts such as sprocket wheels, shafts, bearings, etc., carry a much heavier load. However, too much chain slack is also harmful and causes the chain to climb the sprocket teeth.

### Frequency of Adjustment

Chain has a tendency to stretch a certain amount at the beginning of operation due to slight distortion of its component parts. After such initial elongation, the chain stretches slightly, but constantly, through normal wear. To maintain proper chain tension, necessary adjustments should be made at regular intervals.

#### Frequency of adjustment:

First week of operation:	Once per day
Second to fourth week:	Twice per week
Thereafter:	Twice per month

Note: This frequency schedule is based on daily eight-hour operation. If working hours are increased, the frequency of adjustment should be increased accordingly.

### Even Adjustment of Take-up on Both Sides

This can be easily obtained with cooperating screw type or counterweight type take-ups. When two parallel chains are adjusted by two independently operated take-ups, care must be taken to ensure an even stroke on both the left and right sides. Uneven adjustment will cause the link plate and the side of the sprocket teeth to interfere with each other and result in an overload position.

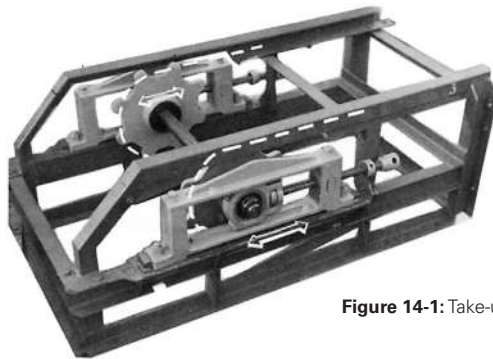

Figure 14-1: Take-up Units

### Insufficient Take-up Adjustment

If the chain is still too long after complete take-up adjustment, shorten it by removing two links.



## Adjustment of Chain Tension for Flow Conveyor

### F Type Flow Conveyor

Proper chain tension for the Tsubaki F Type Flow Conveyor can be determined using the following formulas.

Where:

h = amount of chain slack just behind the head sprocket

L = distance between the sprocket and take-up

1. When material to be conveyed is within a normal temperature range:  
 $h = 0.1250 \times L$
2. When material to be conveyed has a high temperature range:  
 $h = 0.0625 \times L$

To adjust chain slack, it is best to have two people working as a team: one to observe the chain slack at the head section and the other to adjust take-up at the tail section. Adjustments should be made for normal load conditions.

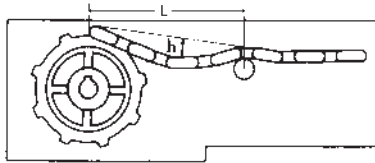

Figure 14-2: Measuring Chain Slack

### L Type and S Type Flow Conveyors

Chain tension for Tsubaki L Type and S Type Flow Conveyors is adjusted by inspecting the chain slack through the inspection door located at the side of the curved section of the casing. Chain slack should be adjusted so that it is at the center of the curved section. Too much tension will cause the chain to rub against the casing, and excessive slack can cause the chain to tangle and break. Proper chain slack can be determined using the following formulas.

Where:

a = distance from the centerline of the chain to the casing

L = distance from the casing to the rail

1. When material to be conveyed is within a normal temperature range:  
 $a = 0.5000 \times L$
2. When material to be conveyed has a high temperature range:  
 $a = 0.2500 \times L$

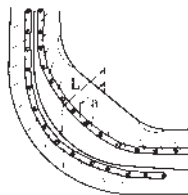

Figure 14-3: Chain Slack for L Type and S Type Flow Conveyors

After a certain period of time, wear will eventually appear on the chain and sprockets. The life of conveyor chain depends on the wear of each component part and on pitch elongation. Periodic inspection of conveyor chain is required more frequently than for roller chain.

The life of conveyor chain component parts is shown below. Periodic inspection of the wearing parts, proper maintenance, and an established schedule for changing the chains is essential for optimum service life.

### Roller Life

When wear between the rail, bushing, and roller causes the under surface of the link plate to contact the rail, the chain has usually reached the end of its usability. As shown in Figure 15-1, when the link plate begins to contact the rail, rolling contact becomes sliding contact between the link plate and rail and results in greater wear, increased chain tension, and reduced horsepower. Such wear generally appears on horizontal or inclined apron conveyors, slat conveyors, etc.

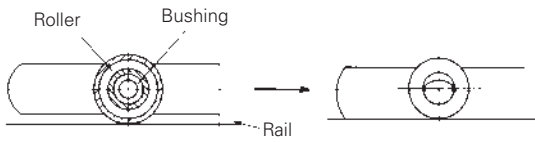

Figure 15-1: Roller Wear

On a curved section of rail, the allowed wear amount is decreased by dimension (S) and requires additional monitoring.

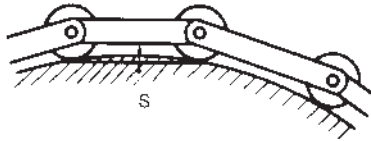

Figure 15-2: Wear on Curved Rail Section

When holes or crevices due to wear appear on the rollers, the chain life has expired.

### Bushing Life

Bushings are generally usable until holes appear. Holes may appear as a result of conveying abrasive materials such as iron ore powder, coke, etc.

### Link Plate Life

Reciprocal friction between the inner and outer link plates and contact between the side surface of the roller and the inside surface of the link plate causes wear such as (A) and (B) shown in Figure 15-3.

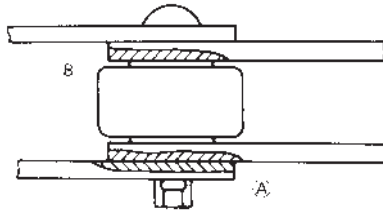

Figure 15-3: Link Plate Wear

Wear that exceeds one-third of the original plate thickness will reduce the tensile strength of the chain. Link plate wear that appears faster than wear on other component parts is usually caused by misalignment of the conveyor during installation. Misalignment can also develop during conveyor operation. Check for the following to ensure maximum working life:

1. Correct alignment of driving and driven sprockets
2. Correct alignment of shafts in horizontal and vertical planes
3. Precision of level gauge and accurate leveling

The link plates on Tsubaki Flow Conveyor Chain move directly on the material to be conveyed or on a steel plate casing. The working life expires when the worn section equals  $A/2$  or  $H/8$ , as shown in Figure 15-4.

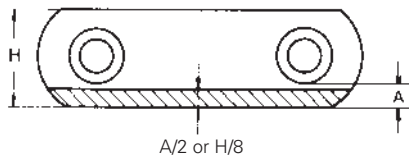

Figure 15-4: Maximum Allowable Link Plate Wear

### Pitch Elongation

When the chain engages with the sprocket or runs on a curved rail section, the chain flexes, which causes the chain to stretch. In most cases, this is caused by wear of the bearing parts, such as pins and bushings. As chain pitch elongation increases, the chain tends to climb the top of the sprocket and prevents smooth conveyor operation. The limit of pitch elongation is generally two percent of the chain pitch.

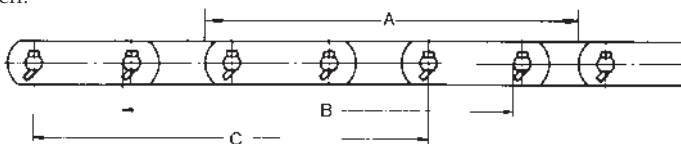

Figure 15-5: Places to Measure Chain Elongation

Figure 15-6 indicates the way to measure chain pitch. Using a steel tape measure, measure as many pitches as possible (at least four are required). Measure length (A), (B), or (C) as shown in Figure 15-5, depending on the wear condition of the chain. The chain pitch elongation per link is determined by comparing the actual pitch to the original chain pitch.



**Figure 15-6:** Measuring Chain Pitch

### Sprocket Life

When the sprocket is worn, chain tends to cling to the sprockets and vibrate. The amount of allowable wear depends on the conveyor type and chain size. Generally, wear to a depth of 3 to 6 mm (0.12 to 0.24 in.) is a sign that the existing sprocket should be repaired or replaced to ensure continued chain life. The following measures can extend sprocket life:

1. Cut section (A) shown in Figure 15-7 with a grinder.
2. Reverse the sprocket to change the engaging area of the teeth.
3. Use a welding rod to obtain the correct tooth profile. However, it is generally more effective to replace the sprocket with a new one.



**Figure 15-7:** Sprocket Wear

If the sprocket teeth are worn as shown in Figure 15-8, sprocket alignment may be incorrect. Proper axial alignment of the sprockets will help reduce or eliminate this type of wear.

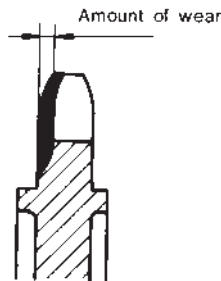

**Figure 15-8:** Sprocket Tooth Wear

## Wear Characteristics of Conveyor Chain

### 1. Mechanical Wear

When conveyor chain is used under normal operating conditions, mechanical wear causes the bearing surface of the chain to shine brightly. Proper lubrication ensures longer wear life.

### 2. Wear Caused by Conveyed Material

Materials having excessive wear characteristics tend to stick to the chain and wear its surface due to reciprocal friction between the chain and material. Care should be taken to prevent material from falling on the chain under these conditions. For extra protection, specify chain with higher wear resistance.

### 3. Wear Due to Corrosion

Conveyor chain used in applications where acidic or alkaline chemicals are present will be subject to corrosive wear as well as mechanical wear. To protect against chemical corrosion accompanying mechanical wear, use corrosion-resistant chain.

### 4. Electrochemical Corrosion

When chain is splashed with water and then enters a chemical solution, the surface of the sliding area (i.e., pin/bushing, bushing/roller) is exposed to electrochemical corrosion, one of the most damaging types of corrosion.

Tsubaki is constantly researching ways to improve the performance of our chains by testing combinations of different materials. Please inquire about our complete line of chains for special environments.

1. Mechanical Wear



3. Wear from Corrosion



2. Wear from Conveyed Materials



4. Electrochemical Corrosion



Figure 15-9: Types of Wear

## 16 RF Conveyor Chain Checkpoints

### Maintenance Checkpoints

Checkpoints	Comments
Centering	A high-precision guide rail is essential to ensure proper centering of the conveyor. If centering is not accurate (with no side guide rail), the conveyor chain will wear and wobble, resulting in shorter chain life.
Sprocket alignment	When two or more sprockets are installed in a row, be sure to align the position of the sprocket teeth. If the sprocket teeth are not properly aligned, the working load will not be equally divided and will cause the chain to twist.
Take-up	If take-up on both sides is uneven, the conveyor chain will not engage smoothly with the sprocket.
Initial chain tension	Maintain adequate chain slack. If chain tension is too high, loss of power will result and can be dangerous. If chain tension is too loose, the chain will climb the sprocket.
Trial run	A trial run after installation should be made under no-load conditions by switching the conveyor on and off several times intermittently. Continuous operation may begin after inspection.
Stopping a conveyor	Stop a conveyor under no-load conditions or remaining material will cause an overload when the system starts again.
Lubrication	Lubricate conveyor chain periodically, except for conveyors that require no lubrication, such as Flow Conveyors. Lubrication is essential for reducer, bearing, and driving roller chain.
Securing conveyor parts	Parts fastened to a conveyor, such as buckets, aprons, slats, etc., are apt to loosen due to vibration. Be sure to fasten nuts and bolts securely and check them periodically.
Amount of chain slack	Regularly check and adjust the amount of chain slack.
Temperature	When differences in temperature, such as summer and winter or between day and night in winter, are severe, conveyor damage may occur. Under these circumstances, operate the conveyor carefully, taking any variations in temperature into account.
Conveyor use and maintenance record	After installing the conveyor, prepare a record of the expected capacity to be conveyed, conveyor speed, r.p.m. of main shaft, electric current, voltage, working hours, actual conveying capacity, inspection date, lubricating date, details of trouble, etc. This will serve as protection against unexpected accidents and is also convenient for maintenance and repairs.

This information is intended to provide general guidelines for roller chain and conveyor chain installation and maintenance. Consult Tsubaki of Canada Limited for specific application problems.

# WARNING

## USE CARE TO PREVENT INJURY COMPLY WITH FOLLOWING TO AVOID SERIOUS PERSONAL INJURY:

1. Guards must be provided on all chain and sprocket installations in accordance with provisions of ANSI/ASME B15.1 — 2000 “Safety Standards for Mechanical Power Transmission Apparatus,” and ANSI/ASME B20.1 — 2000 “Safety Standards for Conveyors and Related Equipment,” or other applicable safety standards. When revisions of these standards are published, the updated edition shall apply.
2. Always lock out the power switch before installing, removing, lubricating or servicing a chain system.
3. When connecting or disconnecting chain:
  - a. Eye protection is required. Wear safety glasses, protective clothing, gloves and safety shoes.
  - b. Support the chain to prevent uncontrolled movement of chain and parts.
  - c. Use of pressing equipment is suggested. Tools must be in good condition and properly used.
  - d. Do not attempt to connect or disconnect chain unless you understand chain construction, including the correct direction for pin/rivet removal or insertion.
  - e. Do not attempt to rework damaged chains by replacing only the components obviously faulty. The entire chain may be compromised, and it should be discarded.
4. Other cautions:
  - a. **Alterations and Repairs** to chains should be made only by qualified personnel with parts and components authorized by Tsubaki of Canada Limited.
  - b. **Electroplating of Assembled Chains** is not condoned. Plating of assembled chains could result in failure from hydrogen embrittlement.
  - c. **Inspect Chains** for shipment damage before installation. During operation, all chain systems should be inspected on a regular schedule. Visually check for worn, damaged and broken parts caused by improper installation or maintenance, abnormal stress, temperature, humidity, abrasion or corrosion, possible interference with other system components and improper lubrication. (For correct lubrication procedures and systems, consult the Tsubaki of Canada Limited Guide to Products and Specifications.)
  - d. **Heating Chain** with a cutting torch is not suggested unless absolutely necessary for removal. If cut in such a manner, it should not be reused.
  - e. **Welding** should not be performed on any chain or component.
  - f. **Average Ultimate Strength** of a chain means the average load at which it will break when subjected to a destructive tensile test. *It does not mean working load.* For complete information, contact Tsubaki of Canada Limited Technical Support Department.
  - g. **Product Dimensions** in this catalog are subject to changes and are intended for general reference only. For exact current dimensions, request certified prints from Tsubaki of Canada Limited.



Driving your business.®

**Tsubaki of Canada Limited, 1630 Drew Road, Mississauga, ON L5S 1J6**  
**Tel: 905-676-0400 Fax: 905-676-0904 Toll-Free: 800-263-7088 [www.tsubaki.ca](http://www.tsubaki.ca) e-mail: [info@tsubaki.ca](mailto:info@tsubaki.ca)**

**TCLi&M06**

**NOTE:** In accordance with the policy of Tsubaki of Canada Limited to consistently improve its products, the specifications in this catalogue are subject to change without notice. Please contact Tsubaki for current prices.

**Printed in Canada MARCH 2006**

Copyright © 2006 Tsubaki of Canada Limited. Errors and Omissions Excepted.

Disclaimer: Tsubaki of Canada Limited makes every effort to ensure that the information in this catalogue is current and accurate, but cannot accept responsibility or liability for any loss or damage suffered as a result of information contained herein.